

9791 rue Meunier,
Montréal,
QC, H3L 2Y7



TEL.: 514-669-3900
1-866-664-3320

info@i-dentaire.com

www.i-dentaire.com

We are specialized in providing you with most of the products needed by a Dental clinic And also we supply orthodontic products and instruments of very high quality

Nous sommes specialisés à vous fournir plusieurs produits requisés par une clinique dentaire. Aussi nous vous offrons les produits et les instruments d'orthodontie d'une qualité supérieur



CATALOGUE 2022

2022 CATALOG



Please note that this catalog contains less than 60% of the products we supply. if you did not find a product you are looking for just call us and we are happy to help you



S.V.P. Notez que cet catalogue contient moins de 60% de produits on fournit. Si vous désirez un produit n'est pas dans le catalogue, Appelez-nous, et on vous aidera.



WITH US
We do not only supply dental products.
But also we help in choosing
the right product
for your procedure.

AVEC NOUS
Vous n'auriez pas seulement le produit
qu'il vous faut.
Mais aussi le conseil qui va avec
pour réussir votre pratique.

Commandez par:
TEL.: 514-669-3900

Order by :
1-866-664-3320

Ou / Or : info@i-dentaire.com

PROMOTIONS

MAXCEM ELITE™

refill
Recharge



Clear
2 x 5gm. syringes
+
mixing tips



Clair
2 x 5gm. seringue
+
embouts mélangeurs

Code: 05-413

\$139.95

KAVO SPRAY



KaVo. Dental Excellence.



QuattroCare spray

\$ 59.95

Kavo spray

\$ 48.95

PROFIL



FILTEK Z250

THE DENTAL
ADVISOR
++++



Profil unidose
compules

\$ 71.85



Profil syringe
seringue

\$ 43.82

Profil Flow
fluide

\$ 54.49

Compules
20 x 0.2gm

Syringe
1 x 4gm.



Compules
20 x 0.2gm

Syringe
1 x 4gm.

Compules

\$ 89.95

Syringes

\$59.95

ADHESE® UNIVERSAL



CAVITRON INSERTS EMBOUTS DE CAVITRON

1 x 2ml. Vivapen
+
100 cannula



1 x 2ml. Vivapen
+
100 cannules

\$159.95

FSI-1000 30K
FSI-SLI-10S 30K
FSI-SLI-10L 25K



FSI-SLI-10S (30K)
FSI-1000 (30K)

\$228.00

FSI-SLI-10L (25K)

\$190.00

BUCHANAN HEAT PLUGGERS FOULOIRS CHAUFFANTS



CLIKRAY SENSOR HOLDERS PORTES CAPTEURS

Fine Medium .08 Taper
952-0005
Medium .10 Taper
952-0006
Medium-Large .12 Taper
952-0007



Moyen Fin .08 Taper
952-0005
Moyen .10 Taper
952-0006
Large moyen .12 Taper
952-0007

Each / Chaque

\$189.95

Compatible with
XCP holders

Posterior
Anterior
BiteWing

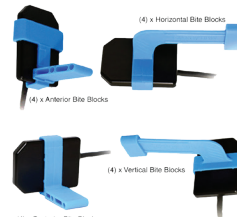

Compatible avec
Dentsply XCP

Postérieur
Antérieur
BiteWing

3/pack - paquet

\$ 29.95

TABLE OF CONTENTS

Crowns & Bridges	4
Acrylics	8
Alloys	9
Anesthesia	10
Retraction & Hemostasis	12
Carbide Burs	14
Diamond Burs	19
Cavity liner & Temporary filling	28
Accessories	30
Masks	31
Gloves	34
Disposables	35
Sterilization	41
Evacuation	42
Disinfectants	43
Endodontics	44
Rubber Dam	47
Finishing & Polishing	48
Equipment	51
Impression materials	53
Impression trays & accessories	57
Instruments	59
Laboratory products	80
Matrix / Wedges / Articulation	81
Needles & Syringes	86
Pins & Posts	87
Preventives	88
Restoratives (Etch & Bond)	91
Restoratives (Composite)	94
Whitening	98
X-Ray products	99
Orthodontics	102

TABLES DE MATIÈRES

Couronnes & Ponts	4
Acryliques	8
Aliages	9
Anesthésie	10
Retraction & Hémostatiques	12
Fraises en carbure	14
Fraises diamantées	19
Fods de cavité & Plombage temporaire	28
Accessoires	30
Masques	31
Gants	34
Jetables	35
Stérilisation	41
Evacuation	42
Désinfectants	43
Endodonties	44
Digue Dentaire	47
Finition & Polissage	48
Equipement	51
Matériaux de prise d'empreintes	53
Portes empreintes & accessoires	57
Instruments	59
Produits de laboratoire	80
Matrices / Coins / Articulation	81
Aiguilles & Seringues	86
Tiges & Tenons	87
Preventifs	88
Restauration (Mordançage & Adhésifs)	91
Restauration (Composite)	94
Blanchiments	98
Produits de X-Ray	99
Orthodonties	102



iDentaire

We offer you the best price on all your ordered products.

We are not official dealer for some manufacturers like 3M, Kerr, etc. But we offer the same warranty offered by the manufacturer on the products we supply.

iDentaire

Nous vous offrons le meilleur prix sur tous les produits commandés

Nous ne sommes pas un fournisseur autorisé pour quelques manufacturiers comme 3M ou Kerr, etc. Mais nous vous offrons la même garantie offerte par les manufacturiers sur leur produits.

ISO FORM CROWNS
COURONNES ISO FORM

3M ESPE POLYCARBONATE CROWNS
COURONNES EN POLYCARBONATE

Tin silver alloy crowns
5/pack



Couronnes en alliage
argent-étain 5/paquet

Premolars & anterior
crowns 5/pack



Dents antérieures et
prémolaires 5/paquet

Refill | Recharge
Code: 01-101

\$ 32.05

Refill | Recharge
Code: 01-102

\$ 14.50

ION NICHRO CROWNS
COURONNES ION NICHRO

UNITEK™ STAINLESS STEEL CROWNS
COURONNES UNITEK EN ACIER

Stainless steel primary
crowns - 5/pack



Couronnes primaire
en acier 5/paquet

Stainless steel primary
or permanent crowns -
5/pack



Couronnes primaire
ou permanent en acier
5/paquet

Refill | Recharge
Code:

\$ 36.99

Refill | Recharge
Code:

\$ 44.99

PROTEMP™ + Temporization Material
Matériau provisoire

KETAC™ CEM

1 cartridge 67gm



1 cartouche de 67gm.

Glass ionomer
sealing cement



Ciment de scellement
au verre ionomère

Refill | Recharge
Code: 01-104

\$169.95

Standard kit
Ensemble standard
33gm. P. + 15ml. Liq.
Code: 05-401

\$ 99.95

Triple pack
Paquet triple
3 x (33gm. P. + 15ml. Liq.)
Code: 05-402

\$259.95

DURELON®

RELY X™ UNICEM 2

Radio-opaque
carboxylate cement



Ciment au carboxylate
radio-opaque

Permanent
light cure
resin cement



Ciment
permanent en
résin photo-
polymérisable

Triple pack | Paquet triple

Powder | Poudre
60gm.
Code: 05-403

\$ 85.39

Liquid | Liquide
40ml.
Code: 05-404

\$ 89.95

Clicker
11gm,
Code: 05-405

\$238.99

Automix
8.5gm.
Code: 05-409

\$188.71

**RELY X™ LUTING CEMENT
LUTING PLUS CEMENT**



Hybrid
Glass ionomer cement



Ciment hybride en
verre ionomère

Standard kit
16gm. P + 9ml. Liq.
Code: 05-406

\$ 159.00

Clicker
1 x 11gm.
Code: 05-407

\$125.84

Clicker double
2 x 11gm.
Code: 05-408

\$218.51



MAXCEM^{MC} ELITE^{MC} / CHROMA

Self-adhesive
Self-etch
resin cement



Ciment en résin
autoadhésif et
automordançant

Clear I Clair
2 x 5gm. syringe I seringue
Code: 05-413

\$139.95

FUJICEM® 2

Resin reinforced cement
auto-adhesive
self-cure



Ciment renforcé à la
résine, auto-adhésif
auto-polymérisable

Refill I Recharge
2 x 13.3gm.
Code: 05-410

\$279.95



GC FUJI PLUS®

Resin reinforced glass
ionomer cement.
Radio-opaque



Ciment au verre ionomère
renforcé à la résine.
Radio-opaque

Kit I Ensemble
15gm.P. & 8ml. Liq.
Code: 05-411

\$201.12

GC Fuji I®

Glass ionomer cement



Ciment en verre ionomère

Kit I Ensemble
35gm.P. & 20ml. Liq.
Code: 05-412

\$159.95



FLECK'S® CEMENT

Zinc phosphate cement



Ciment au phosphate
de zinc

Powder I Poudre
29gm.
Code: 05-415

\$ 20.22

Liquid I Liquide
35ml.
Code: 05-414

\$ 26.97

MULTILINK® AUTOMIX

Universal resin cement
dual cure
self-etch



Ciment-résine universel
à polymérisation double,
automordançant

System pack I Paquet système
9gm. sy., + Primer & adhesive
Code: 05-416

\$349.95

Refill I Recharge
seringue 9gm. syringe
Code: 05-418

\$249.95



**MULTILINK® PRIMER A&B
APPRÊT A&B**



1 x 3gm. bottle of each primer (A & B).
1 x 3gm. bouteille de chaque Apprêt (A&B)
Code: 05-417

\$ 119.87

TEMPORARY C & B MATERIAL
MATÉRIAU PROVISOIRE POUR C&P

POLYCARBONATE CROWNS
COURONNES EN POLYCARBONATE



MADE IN USA



1 cartridge 75gm.
A1 / A2 / A3

10: 1

1 cartouche 75gm.
A1 / A2 / A3

Premolars & anterior
crowns 5/pack

Dents antérieures et
prémolaires 5/paquet

Refill | Recharge
Code: 01-105

\$123.95

Refill | Recharge
Code: 01-103

\$ 5.99

LUXATEMP AUTOMIX PLUS



AIDACO BITE STICKS

BÂTONNETS OCCLUSAUX



1 cartridge (76g)
+ 15 tips

1 cart. (76 g)
et 15 embouts

6" x 3/16"



6" x 3/16"

Refill | Recharge
Code: 01-107

\$259.95

80/PACK | 80/PAQUET
Code: 01-122

\$ 31.46

VITA CLASSICAL SHADE GUIDE
GUIDE DE TEINTE CLASSIQUE VITA



UNIVERSAL SHADE GUIDE
GUIDE DE TEINTE UNIVERSAL



A1-D4

A1-D4



A-D

A-D

1/PACK | 1/PAQUET
Code: 01-1201

\$174.95

1/PACK | 1/PAQUET
Code: 01-120

\$ 53.93

MARK 3 C&B MIXING TIPS
C&P EMOBOUTS MÉLANGEURS



PRESSURE INDICATOR PASTE
PÂTE INDICATEUR DE PRESSION



Blue 1:10
25 tips

Bleu 1:10
25 embouts

2.25oz.



2.25oz

Refill | Recharge
Code: 01-119

\$ 38.00

Refill | Recharge
Code: 01-121

\$ 30.34

CROWN & BRIDGE

COURONNES ET PONTS

INTEGRITY®



1 Cartridge (76g) +
20 Mixing Tips
A1 / A2 / A3 / A3.5 / B1

1 Cartouche (76g) +
20 Embouts
A1 / A2 / A3.5 / B1

Refill | Recharge
Code: 01-106

\$229.95



STRUCTUR 2-SC



75gm. cartridge
+ 6 mixing tips

1 cartouche de 75gm
+ 6 embouts

Refill | Recharge
Code: 01-113

\$174.95

SNAP^{MC}



SMARTEMP™

Temporary crown &
bridge material



Matériau pour
couronnes et ponts
provisoires



Powder Refill | Recharge poudre
Code: 01-110 (40gm.)

\$ 37.41

1-50 mL cartridge
+ 10 mixing tips.

1 cartouche (76 g)
et 10 embouts

Liquid Refill | Recharge liquide
Code: 01-111 (4oz.)

\$ 39.95

Refill | Recharge
Code: 01-112

\$98.88

TEMP-BOND™



TEMP-BOND™ AUTOMIX / CLEAR

Self-cure temporary
cement



Ciment provisoire
auto polymérisable

Automix:
2 x 11.gm, syringes
Clear:
1 x 6gm. syringe



Auto-mélangeurs:
2 x 11.5gm, ser.
Clair:
1 x 6gm. seringue

**2 tubes
base 50gm. +
accelerator 15gm,**
Code: 05-302

\$ 54.00

**Unidoses
50 x 2.4 g
(120gm. total)**
Code: 05-303

\$ 74.64

Automix
Code: 05-301

\$ 76.00

Clear
Code: 05-304

\$ 76.00

VISCO-GEL



IVOCLEAN

120g Powder
90ml Liquid
15ml Lubricant



120g Poudre
90ml Liquide
15ml Lubrifiant

Extraoral cleaning of
pre-treated ceramic
and metal restoration
surfaces



Nettoie efficacement
tous les types de
matériaux de
restauration

Refill | Recharge
Code: 01-118

\$169.95

Refill | Recharge
Code: 01-123 (5gm.,)

\$ 42.13

ACRYLICS

ACRYLIQUES

ALIKE™



Powder Refill | Recharge poudre
Code: 01-109 (45gm.)

\$ 44.94

Liquid Refill | Recharge liquide
Code: 01-108 (4oz.)

\$ 43.82



COE-COMFORT™



Tissue conditioner

1 (6 oz) powder,
1 (6 oz) liquid,

Conditionneur de tissu

1 (6 oz) de poudre,
1 (6 oz) liquide

Professional pack | Emballage professionnel
Code: 01-114

\$179.95

COE-SOFT™



KOOLINER™

Reline

1 (6 oz) powder,
1 (6 oz) liquid,



Regarnissage

1 (6 oz) de poudre,
1 (6 oz) liquide

Professional pack | Emballage professionnel
Code: 01-115

\$179.95

Hard Denture Reline

1 (3 oz) powder,
1 (2 oz) liquid,



Matériau De Rebasage De
Prothèse Dur

1 (3 oz) de poudre,
1 (2 oz) liquide

Professional pack | Emballage professionnel

Code: 01-116

\$149.29

Ufi Gel hard C



Hard Denture Reline



Matériau De Rebasage
De Prothèse Dur

Refill | Recharge
Code: 01-117 (50ml.)

\$159.95



DENTUSIL™

Chairside soft silicone
relining material



Matériaux résistants
de silicone de
rebasage souple

Code: 0921276
50ml. cartridge + 14ml. liquid
cartouche (50 ml),+ liquide (14 ml)

\$218.31

TRUSOFT™



FASTRAY™ LC

Intermediary Denture
Reliner



Regarnissage
intermediare

Standard kit / Emb. standard (0921276)
1 (3 oz) pink powder, 1 (4 oz) liquid, 1 (1/3 oz) bonding liquid,
Poudre rose: 3oz. + Liquide: 4oz. + Adhésif 1/3oz.

\$ 89.95

Custom tray acrylic
base material
Blue- 0921405
Pink- 0921406
White:-0921407



Matériau pour
prise d'empreintes
personnalisés
Bleu- 0921405
Rose- 0921406
Blanc:-0921407

50/box - boîte

\$139.95

ALLOYS

ALIAGES

SPHERODON-M®

Admix Alloy,
High Copper,
Non Gamma II



45,5 % argent,
Haute teneur
en cuivre,
Non gamma II

50 caps. 2 spill | 50 caps. 2 portions
Code: 02-102 (600mgm)

\$ 89.00

500 caps. 2 spill | 500 caps. 2 portions
Code: 02-103 (600mgm)

\$922.47



SILMET SPHERODON +®

100% Spherical Alloy,
56% Ag,
High Copper,
Non Gamma II



Alliage sphérique 100%
56% argent
Haute teneur en cuivre,
Non gamma II

50 caps. 2 spill | 50 caps. 2 portions
Code: 02-104 (600mgm)

\$110.11

500 caps. 2 spill | 500 caps. 2 portions
Code: 02-105 (600mgm)

\$1008.99

DISPERSALLOY

Fast set



Prise rapide

50 caps. 1 spill | 50 caps. 1 portion
Code: 02-106 (400mgm)

\$128.65

50 caps. 2 spill | 50 caps. 2 portions
Code: 02-107 (600mgm)

\$155.06



TYTIN FC®



FS 1 SPILL 500 CAP 400 MG	Prise rapide	\$1 147.50
RS 1 SPILL 500 CAP 400 MG	Prise régulière	\$1 147.50
FS 2 SPILL 500 CAP 600 MG	Prise rapide	\$1 417.50
RS 2 SPILL 500 CAP 600 MG	Prise régulière	\$1 417.50
FS 3 SPILL 500 CAP 800 MG	Prise rapide	\$1 533.21
RS 3 SPILL 500 CAP 800 MG	Prise régulière	\$1 533.21

CONTOUR®



TYTIN®



RS 2SPILL 600 MG 500/PK	Prise régulière	\$1 128.21
RS 3SPILL 800MG 500/PK	Prise régulière	\$1 301.79
RS 1SPILL 400MG 500/PK	Prise régulière	\$1 147.50
FS 2SPILL 600 MG 500/PK	Prise rapide	\$1 215.00
FS 3SPILL 800MG 500/PK	Prise rapide	\$1 398.21

1 SPILL REG. SET 500/PK 400 MG	Prise régulière	\$ 896.79
2 SPILL REG. SET 500/PK 600 MG	Prise régulière	\$1 089.64
3 SPILL REG. SET 500/PK 800 MG	Prise régulière	\$1 243.93

GS-80

Admix Alloy,
40% silver,
Non Gamma II



Aliage admix
40 % d'argent
Non gamma II

02-111	1 SPILL 500 CAPS.	Fast set	\$ 720.00
02-112	2 SPILL 50 CAPS.	Reg. set	\$ 89.95
02-113	2 SPILL 500 CAPS.	Reg. set	\$ 874.72
02-114	3 SPILL 50 CAPS.	Reg. set	\$ 98.31
02-115	3 SPILL 500 CAPS.	Fast set	\$1044.38
02-116	5 SPILL 50 CAPS.	Reg. set	\$ 110.11



PERMITE

Admix Alloy,
56% Silver,
Non Gamma II



Alliage admix
56% argent
Non gamma II

02-117	1 SPILL 50 CAPS.	Fast set	\$ 86.03
02-118	2 SPILL 50 CAPS.	Fast set	\$ 110.11
02-119	3 SPILL 50 CAPS.	Reg. set	\$ 156.00

ANESTHESIA

ANESTHÉSIE

XYLOCAINE 2%

Lidocaine HCL 2%
1: 100 000 red
OR
1: 50 000 green



50/box | 50/boîte
Code: 03-109

\$ 37.95



ASTRACAINE 4%

Articaine HCL 4%
1: 100 000 bleu
OR
1: 200 000 green



100/box | 100/boîte
Code: 03-108

\$118.00

CITANEST 4%

Prilocaine HCL 4%
Plain
OR
1: 200 000



50/box | 50/boîte
Code: 03-105

\$ 53.95



SEPTANEST® SP / SEPTANEST® N

Articaine HCL 4%
1: 100 000 SP
OR
1: 200 000 N



50/box | 50/boîte
Code: 03-110

\$ 69.95

HCL Articaine 4%
1: 100 000 SP
OU
1: 200 000 N

LIDOCAINE 2%

Lidocaine HCL 2%
1: 100 000 red
OR
1: 50 000 green



50/box | 50/boîte
Code: 03-107

\$ 54.00



CARBOCAINE 3%

Mepivacaine HCL 3%
Plain



50/box | 50/boîte
Code: 03-106

\$ 84.00

HCL Mèpivacaine 3%
Plain

TOPEX®

Topical Anesthetic Gel
20% benzocaine
Cherry / Pina Colada /
Bubble Gum / Mint /
Strawberry / Raspberry



30gm. | 1oz.
Code: 03-102

\$ 14.95



Gel Anesthésie Topique
20% benzocaine
Cerise / Menthe /
Pina Colada / Fraises /
Gomme balloune /
Framboise



CANDI-CAINE

Topical Anesthetic Gel
20% benzocaine
Cherry / Pina Colada /
Bubble Gum / Mint /
Strawberry / Raspberry /
Grape



30ml. | 1oz.
Code: 03-101

\$ 10.00

Gel Anesthésie Topique
20% benzocaine
Cerise / Menthe /
Pina Colada / Fraises /
Gomme balloune /
Framboise / Raisin

HURRICAIN SPRAY

20% benzocaine



Benzocaine 20%

57gm. | 2oz.
Code: 03-104

\$ 51.69

**SELF-ASPIRATING SYRINGE
SERINGUE AUTOASPIRANTE**



76-100

1.8ML.

\$ 83.95



TOPICALE® XTRA

20% benzocaine



Benzocaine 20%

28.35gm. | 1oz.
Code: 03-103

\$ 14.55



ORAQIX®

Needle-free, topical anesthetic.
Lidocaine 2.5% and Prilocaine Periodontal Gel 2.5%



Anesthésique topique sans aiguille
Gel parodontal à 2,5 % de lidocaïne et 2,5 % de prilocaïne

20/Box - Boîte

\$ 159.95

**ASPIRATING SYRINGE
SERINGUE ASPIRANTE**



Each / Chaque
Code: 11-324

\$ 27.99



**SELF-ASPIRATING SYRINGE
SERINGUE AUTOASPIRANTE**

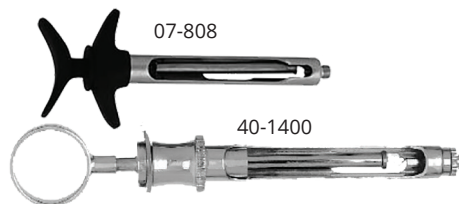

07-808

40-1400

Each / Chaque
07-808 / 40-1400

\$ 29.95

**INTRA-LIGAMENTAL SYRINGE
SERINGUE INTRA-LIGAMENTAIRE**



Each / Chaque
Code: 11-325

\$ 69.99

**YOUNG TONGUE HOLDER
PORTE LANGUE YOUNG**



Each / Chaque
24-4500

\$ 29.95

RETRACTION & HEMOSTASIS

RÉTRACTION ET HÉMOSTATIQUES

SPONGOSTAN™



Absorbable haemostatic gelatin sponge



Éponge en Gélatine résorbable

24/box | 24/boîte
Code: 03-111

\$ 48.00

GELITA® MEDICAL

Complete Care! Completely Safe!

Absorbable haemostatic gelatin sponge
10 x 10 x 10 mm



Éponge en Gélatine résorbable
10 x 10 x 10 mm

50/box | 50/boîte
Code: 03-112

\$ 94.95

EXPASYL



Gingival retraction system
Strawberry flavor



Système de rétraction gingivale
Savoir de fraise

20 caps./box | 20 caps./boîte
Code: 03-113

\$350.00

Applicators 40/box | Applicateurs 40/boîte
Code: 03-114

\$ 101.01

parkell DRYZ™

Gingival Hemostatic Retraction Paste

7 syringes + 15 applicators



Pâte hemostatique pour le gingivice

7 seringues + 15 applicateurs

Standard pack | Paquet standard
Code: 03-115

\$114.00

HEMODENT®

Buffered aluminum chloride (epinephrine free)



Chlorure d'aluminium tamponné (sans épinéphrine).



40 ml./bottle | 40 ml./bouteille
Code: 03-116

\$ 74.00

10 ml./bottle | 10 ml./bouteille
Code: 03-117

\$ 24.95

TRAXODENT®

15% Aluminum chloride paste.



Pâte de chlorure d'aluminium à 15%

2 syringes | 2 seringues
Code: 03-119

\$ 43.82

7 syringes | 7 seringues
Code: 03-120

\$134.00

25 syringes | 25 seringues
Code: 03-121

\$352.81

50 applicators | 50 applic. Code: 03-122

\$ 66.01

COE-PAK™

Periodontal dressing
1 base (90gm.) + 1 catalyst (90gm.)



Pansement parodontal
1 base (90 g) et 1 catalyseur (90 g)

Regular set | Prise régulière
Code: 03-123

\$ 87.99



Surgical hemostatic dressing

ALVEOGLY



Pansement chirurgical hémostatique

10gm. jar | Pot 10gm.
Code: 03-126

\$109.00

ULTRAPAK®



100% cotton



En coton à 100 %

1 bottle | 1 bouteille
Code: 03-123

\$ 21.00

15.5% ferric sulfate solution



Une solution ferrique acquee à 15,5 %

30ml. bottle | Bouteille de 30ml.
Code: 03-118

\$ 71.91

VISCOSTAT®



20% ferric sulfate solution



Une solution ferrique acquee à 20 %

30ml. syringe | seringue 30ml.
Code: 03-125

\$ 69.95

25% Aluminum chloride



25% Chlorure d'aluminium

30ml. syringe | seringue 30ml.
6408

\$ 69.95

FORMO CRESOL



MASTER-DENT™

48.5% formaldehyde, 48.5% Cresol, 3% Glycerin



48.5% formaldéhyde, 48.5% Crésol, 3% Glycerine

30ml. bottle | bouteille de 30ml.
Code: 03-127

\$ 79.95

Baxter SALINE SOLUTION EAU SALINE

0.9% Sodium chloride



0.9% chlorure de sodium

500ml. bottle | bouteille de 500ml.
Code: 03-128

\$ 7.30

HELMEND® ADVANCED



HELIPLUG® / HELITAPE®

Resorbable advanced collagen membrane 18 weeks



Membrane avancée de collagène résorbable 18 semaines



62-206	15mm X 20mm	\$165.47
62-207	20mm X 30mm	\$198.55
62-208	30mm X 40mm	\$340.20

HeliPlug
3/8" x 3/4" (1cm x 2cm)
62-202 (10/Box - Boîte)

\$169.99

HeliTape
1" x 3" (2.5cm x 7.5cm)
62-200

\$283.99

OPERATORY

OPERATOIRE

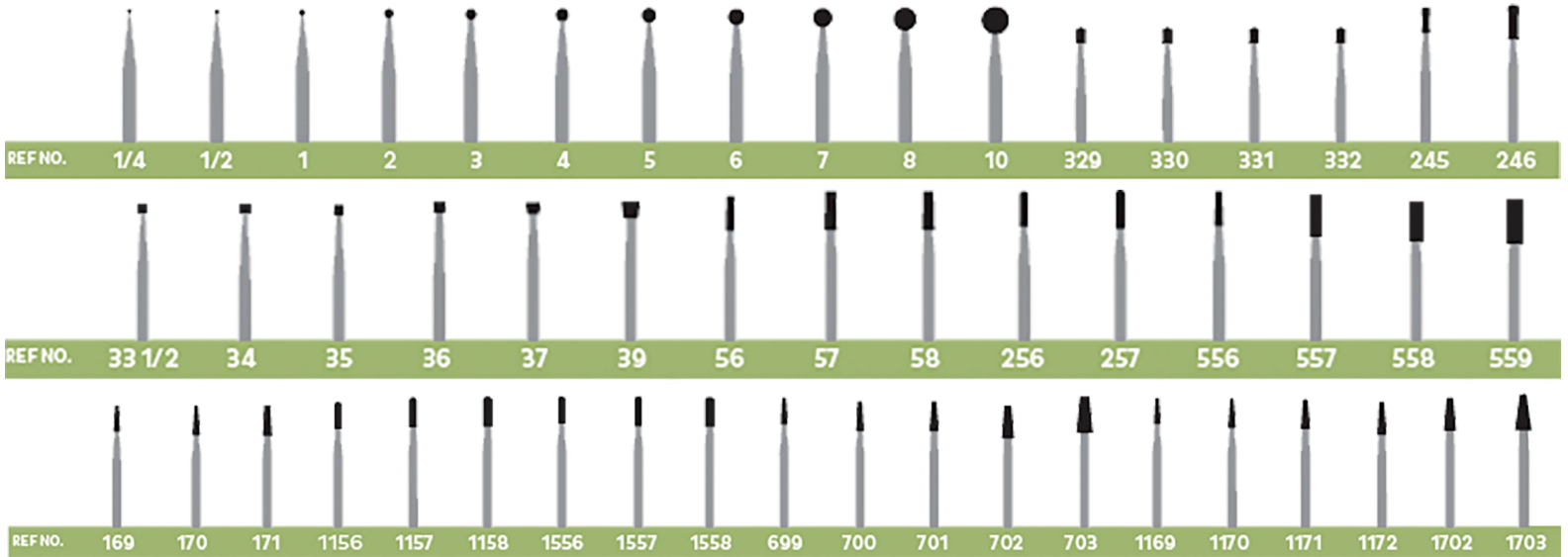

KERR BEAVER carbide burs
fraises en carbure **KAVO** **Kerr**
 Morrisburg Operations
 Operating as Beavers Dental since 1947

simply better dentistry
SS WHITE carbide burs
fraises en carbure

OPERATORY

OPERATOIRE

FG

Each | Chaque
 Code: 04-106

\$ 1.55

European Union Representative
 Kavo Italia S.p.A.
 Via Passarè, 3/2
 I-38018 Cortina (TN) Italy

CE 0086

FGOS557
 100 Carbide Burs
 Part No: 00400191
 LOT 6095632 09/30/16

Made in Canada

Beavers Dental
 55 Laurier Drive
 Morrisburg, ON
 Canada K5C 1X0

Rx Only

102096 155 1 0

RA

Each | Chaque
 Code: 04-108

\$ 1.66

OPERATORY

OPERATOIRE

FG

10/pack | 10/paquet

\$ 29.17



RA

10/pack | 10/paquet

\$ 25.51

SURGICAL

CHIRURGICAUX

FGOS

Each | Chaque
 Code: 04-107

\$ 2.95

RAOS

Each | Chaque
 Code: 04-109

\$ 2.56

SURGICAL

CHIRURGICAUX

FGOS

5/pack | 5/paquet
 Code: 04-

\$ 23.14

RAOS

5/pack | 5/paquet
 Code: 04-114

\$ 21.91

HB TRIMMING & FINISHING
TAILLAGE ET FINITION



BARRACUDA METAL CUTTING
COUPE MÉTAL



12 flutes | 12 lames
 Code: 04-102
 Each / Chaque

\$ 4.85

30 flutes | 30 lames
 Code: 04-103
 Each / Chaque

\$ 6.95

2	4	6	8	34	35	37	330	331	556	557	558	701	702	1557	1558	
010	014	016	023	008	010	014	008	008	010	009	010	012	012	016	010	012
				0.9	1.1	1.4	2.7	1.6	1.7	4.2	4.2	4.2	4.2	4.2	4.2	4.2

Each / Chaque
 Code: 04-105

\$ 6.18

DENTSPLY ENDO Z Code: 04-104

\$ 7.95





PREMIUM CARBIDE BURS • MADE IN CANADA

- Precision ground cutting edges for consistent cutting performance.

SOLID CARBIDE ONE - PIECE CONSTRUCTION • MADE IN USA

- Eliminates joint breakage
- A highly concentric bur results in a faster, smoother and more precise cut.

330, 331 & 245 with Crosscut

	CROSSCUT PEAR		CROSSCUT	AMALGAM PREP
ISO No.	330	331	245	
ISO Ø 1/10 (mm)	008	010	008	
Head Length (mm)	1.6	1.7	2.7	
6 BLADES				
FG – One Piece- USA	PTC330	PTC331	PTC245	
SS(Short) – One Piece- USA	PTCSS330		PTCSS245	



FG - Friction Grip
SS - FG Short Shank

OS - FG with Surgical Length

RA - For Use in Latch-Type angles
RASS - RA Short Shank
HP - For Use in Straight Nose Cones

RAOS - RA with Surgical Length

	ROUND											AMALGAM PREP			
ISO No.	1/4	1/2	1	2	3	4	5	6	7	8	245	246	256	257	
ISO Ø 1/10 (mm)	005	007	008	010	012	014	016	018	021	023	008	012	008	010	
Head Length (mm)											2.7	2.7	4.2	4.2	
6 BLADES															
FG – CANADA		1/2	1	2	3	4	5	6	7	8	245	246	256	257	
FG – One Piece- USA	1/4-1p	1/2-1p	1-1p	2-1p	3-1p	4-1p	5-1p				245-1p	246-1p	256-1p		
SS (Short)-CANADA	SS1/4	SS1/2	SS1	SS2	SS3	SS4	SS5	SS6		SS8	SS245				
SS(Short) – One Piece- USA			SS1-1p	SS2-1p		SS4-1p					SS245-1p				
OS (Surgical) –CANADA	OS1/4	OS1/2	OS1	OS2	OS3	OS4		OS6		OS8					
OS (Surgical) One Piece- USA			OS1-1p	OS2-1p	OS3-1p	OS4-1p									
RA –CANADA	RA1/4	RA1/2	RA1	RA2	RA3	RA4	RA5	RA6	RA7	RA8	RA245				
RASS –CANADA		RASS1/2	RASS1	RASS2	RASS3	RASS4	RASS5	RASS6							
RAOS –CANADA		RAOS1/2	RAOS1	RAOS2	RAOS3	RAOS4		RAOS6		RAOS8					
HP –CANADA	HP1/4	HP1/2		HP2		HP4		HP6		HP8					

	INLAY PREP	INVERTED CONE									ROUND END CROSSCUT			
ISO No.	271	33 1/2	34	35	36	37	38	39	37L	1556	1557	1558	1559	
ISO Ø 1/10 (mm)	012	007	008	010	012	014	016	018	014	009	010	012	014	
Head Length (mm)	2.7	0.5	0.9	1.1	1.2	1.4	1.6	1.7	4.4	3.7	3.7	3.7	3.7	
6 BLADES														
FG – CANADA	271	33 1/2	34	35	36	37	38	39	37L	1556	1557	1558		
FG – One Piece- USA		33 1/2-1p	34-1p	35-1p	36-1p	37-1p				1556-1p	1557-1p	1558-1p	1559-1p	
SS (Short)-CANADA		SS33 1/2	SS34	SS35	SS36						SS1557	SS1558		
SS(Short) – One Piece- USA		SS33 1/2-1p		SS35-1p							SS1557-1p			
OS (Surgical) –CANADA											OS1557	OS1558		
OS (Surgical) One Piece- USA											OS1557-1p	OS1558-1p		
RA –CANADA		RA33 1/2	RA34	RA35		RA37					RA1557			
RASS –CANADA			RASS34											
HP –CANADA						HP37						HP1558		



	CROSSCUT STRAIGHT FISSURE										STRAIGHT FISSURE			
ISO No.	555	556	557	558	559	560	556L	557L	558L	55	56	57	58	
ISO Ø 1/10 (mm)		009	010	012	014	016	009	010	012	008	009	010	012	
Head Length (mm)		4.2	4.2	4.2	4.4	4.4	6	6	6	4.2	4.2	4.2	4.2	
6 BLADES														
FG – CANADA		556	557	558		560	556L	557L	558L	55	56	57	58	
FG – One Piece– USA	555-1p	556-1p	557-1p	558-1p	559-1p		556L-1p	557L-1p	558L-1p			57-1p	58-1p	
SS (Short)–CANADA		SS556	SS557	SS558						SS56	SS57	SS58		
SS(Short) – One Piece– USA		SS556-1p	SS557-1p	SS558-1p							SS57-1p	SS58-1p		
OS (Surgical) –CANADA		OS556	OS557	OS558	OS559									
OS (Surgical) One Piece– USA			OS557-1p	OS558-1p			OS557L-1p							
RA–CANADA		RA556	RA557	RA558						RA56	RA57			
RASS–CANADA											RASS57			
HP–CANADA			HP557											

	STRAIGHT FISSURE					ROUND END TAPER						
ISO No.	59	60	56L	57L	58L	1169	1170	1171	1172	1169L	1170L	1171L
ISO Ø 1/10 (mm)	014			010	012	009	010	012	016	009	010	012
Head Length (mm)	4.4			6.0	6.0	3.7	3.7	3.7	4.2	6	6	6
6 BLADES												
FG – CANADA	59	60	56L	57L	58L	1169	1170	1171	1172	1169L	1170L	1171L
FG – One Piece– USA	59-1p			57L-1p			1170-1p	1171-1p				
RA–CANADA								RA1171	RA1172			

	ROUND END TAPER CROSSCUT		CROSSCUT TAPERED FISSURE									
ISO No.	1701	1702	699	700	701	702	703	699L	700L	701L	701XL	702L
ISO Ø 1/10 (mm)	012	016	009	010	012	016	021	009	010	012	012	016
Head Length (mm)	4.4	4.4	4.2	4.2	4.2	4.4	4.8	5.2	6.0	6.0		6.0
6 BLADES												
FG – CANADA	1701	1702	699	700	701	702	703	699L	700L	701L		
FG – One Piece– USA			699-1p	700-1p	701-1p	702-1p		699L-1p	700L-1p	701L-1p		702L-1p
SS (Short)–CANADA			SS699	SS700	SS701							
SS(Short) – One Piece– USA				SS700-1p	SS701-1p							
OS (Surgical) –CANADA		OS1702		OS700	OS701	OS702	OS703					
OS (Surgical) One Piece– USA				OS700-1p	OS701-1p	OS702-1p				OS701XL-1p	OS702L-1p	
RA–CANADA			RA699	RA700	RA701	RA702						
HP–CANADA					HP701	HP702	HP703					

	WHEEL	PEAR								ROUND END FISSURE			
ISO No.	14	329	330	331	332	330L	331L	332L	333L	1155	1156	1157	1158
ISO Ø 1/10 (mm)	012	006	008	010	012	008	010	012	014	008	009	010	012
Head Length (mm)		1.2	1.6	1.7	1.8	3.8	3.8	3.8	3.8	3.7	3.7	3.7	3.7
6 BLADES													
FG – CANADA	14	329	330	331	332		331L	332L	333L	1155	1156	1157	1158
FG – One Piece– USA		329-1p	330-1p	331-1p	332-1p	330L-1p	331L-1p				1156-1p	1157-1p	1158-1p
SS (Short)–CANADA		SS329	SS330	SS331						SS1156	SS1157	SS1158	
SS(Short) – One Piece– USA			SS330-1p	SS331-1p									
OS (Surgical) –CANADA													OS1158
OS (Surgical) One Piece– USA													
RA–CANADA			RA330		RA332								



\$4.85

EA / CH.

12 FLUTES FINISHING BURS

RA-For Use in Latch-type angles • Made in Canada

RA FINISHING					
ISO No.					
ISO Ø 1/10 (mm)	010	014	018	018	010
Head Length (mm)				3.4	3.6
RA 12 FLUTES 5 Per Pkg.					
12 FLUTES	RA7002	RA7004	RA7006	RA7406	RA7902

ENDO ACCESS BURS • MADE IN USA

Solid Carbide One-Piece Construction

ISO No.	4219EZ	4152EZ	40199Z	40151Z
ISO Ø 1/10 (mm)	014	014	016	016
Head Length (mm)	9.0	8.5	9	11
TD (mm)	0.70	0.90		
ENDO ACCESS BUR PACKS OF 5				
ENDO ACCESS	4219EZ	4152EZ	40199Z	40151Z

12 & 30 FLUTES TRIMMING & FINISHING BURS • In Friction Grip

Solid Carbide One-Piece Construction • Made in USA

Premium Quality Carbide Burs • Made in Canada

12 FLUTES • 5 bur Pkg.

30 FLUTES • 5 bur Pkg.

\$6.95

EA / CH.

ISO No.	COMPOSITE TRIMMING				CYLINDER	INTERPROXIMAL	
	008	010	014	014		012	010
ISO Ø 1/10 (mm)					012		
Head Length (mm)	3.0	4.2	6.0	9.0	8	3.2	6.0
12 & 30FLUTES							
12 F. USA	EF3	EF4	EF6	EF9	7572	7103	7602
30 F. USA	UF3	UF4	UF6	UF9	9572		

ISO No.	ROUND						FLAME						CHAMFERING	
	2	3	4	6	8	9	012	014	018	023	016	010	012	015
ISO Ø 1/10 (mm)	010	012	014	018	023	027	3.5	3.5	3.8	4.6	3.5	8.0	8.0	
Head Length (mm)														
12 & 30FLUTES														
12 F. USA	7002	7003	7004				7102	7104			H274	H48L01	H48L01	7345
12 F. CANADA				7006	7008	7009		7104M	7106	7108				
30 F. USA			9004	9006	9008									

ISO No.	FLAT END TAPER						BULLET				LING BEAR		CURRETAGE	
	014	010	012	014	016	018	OS3	OS2	010	012	012	014	016	016
ISO Ø 1/10 (mm)	014	010	012	014	016	018	007	009	010	012	012	014	016	016
Head Length (mm)	8.0	5.2	5.2	9.0	9.0	9.0	3.2	3.2	3.4	3.4	4.2	4.2	6.0	8.0
12 & 30FLUTES														
12 F. USA	7714						7800	7801	7802	7803	7303	7304	7282K6	7283K6
12 F. CANADA	7714M	7702	7713	7204	7205	7206		7801M	7802M	7803M				
30 F. USA	9714		9713				9800	9801	9802	9803				

ISO No.	ROUND END TAPER				EGG			NEEDLES				PARALLEL BEVEL		
	010	012	014	016	014	018	OS1	009	010	012	014	012	014	
ISO Ø 1/10 (mm)	010	012	014	016	014	018	023	009	010	012	014	012	014	
Head Length (mm)	8.0	8.0	8.0	8.0	2.8	3.4	4.2	3.6	3.6	3.6	3.6	8.0	8.0	
12 & 30FLUTES														
12 F. USA	7642	7653	7664	7675	7404	7406	7408	7901	7902	7903			72832	72834
12 F. CANADA	7642M		7664M		7404M	7406M	7408M	7901M	7902M	7903M				
30 F. USA	9642				9404	9406	9408				9903	9904		

ISO No. ISO Ø 1/10 (mm) Head Length (mm)	END CUTTING		Tapered fissure								
	956	957	167	168	169	170	171	172	169L	170L	171L
	008	010	007	008	009	010	012	016	009	010	012
Head Length (mm)			3.2	3.2	3.2	3.7	3.7	4.4	5.2	6.0	6.0
6 BLADES											
FG – CANADA			167	168	169	170	171	172	169L	170L	171L
FG – One Piece- USA	956-1p	957-1p			169-1p	170-1p	171-1p		169L-1p	170L-1p	171L-1p
SS (Short)-CANADA					SS169	SS170	SS171				
SS(Short) – One Piece- USA	SS956-1p	SS957-1p									
OS (Surgical) –CANADA							OS171				
OS (Surgical) One Piece- USA											
RA-CANADA						RA170					
RASS-CANADA						RASS170					



FINE CROSSCUT "BEAVER" BURS • CRISS CROSSCUT • MADE IN CANADA
10 Per Pkg.

	Fine Crosscut Pear Shape (Little Beaver)			Fine Crosscut Amalgam Prep		Fine Crosscut Straight Dome (Big Beaver)			Fine Crosscut Taper Dome		
ISO No.	1930	1931	1932	1945	1946	1956	1958	1958L	1969	1970	1971
ISO Ø 1/10 (mm)	0.08	010	012	008	012	009	012	012	009	010	012
Head Length (mm)	1.5	1.5	1.5	2.7	3.7	3.2	3.7	4.9	3.2	3.7	3.7
FG – CANADA	1930	1931	1932	1945	1946	1956	1958	1958L	1969	1970	1971

	Criss Crosscut Straight Dome		Criss Crosscut Taper Dome		Fine Crosscut Straight Fissure			Fine Crosscut Taper Fissure		
ISO No.	2157	2158	2170	2171	2056	2057	2058	2069	2070	2071
ISO Ø 1/10 (mm)	010	012	010	012	009	010	012	009	1.0	012
Head Length (mm)	3.7	3.7	3.7	3.7	3.2	3.7	3.7	3.2	3.7	3.7
FG – CANADA	2157	2158	2170	2171	2056	2057	2058	2069	2070	2071

METAL/CROWN CUTTERS • CROWN/BRIDGE PREP • SOLID CARBIDE ONE-PIECE • MADE IN USA
BARRACUDA **SPEEDSTER**



METAL/CROWN CUTTERS										
ISO No.	245	330	557	2	558	556	701	1557	1558	
ISO Ø 1/10 (mm)	008	008	010	010	012	009	012	010	012	
Head Length (mm)	2.7	1.9	4.2		4.2	4.2	4.2	4.2	4.2	
BARRACUDA										
METAL CUTTER	MC245	MC330	MC557	MC2	MC558	MC556	MC701	MC1557	MC1558	

	ROUND END TAPER				FLAT END TAPER				FOOTBALL
ISO No.	856	856	856	856	847	847	847	847	379
ISO Ø 1/10 (mm)	012	014	016	018	012	014	016	018	023
Head Length (mm)	8	8	8	8	8	8	8	8	5
SPEEDSTER									
CROWN PREP	CR856-012	CR856-014	CR856-016	CR856-018	CR847-012	CR847-014	CR847-016	CR847-018	CR379-023



B6LC is #1 rated Zirconia Cutting Diamond for Crown Removal by independent non-profit dental education and product testing foundation. B6LC is not a special bur, all our diamond burs have this same cutting efficiency.

FG		TRIM & FINISH											ACORN				
ISO No.		132	133	134	135	804	247	889	889	833	392A	392	369A	905	905	905	
ISO Shape No.		DET3	DET4	DET6	DET9												
ISO Ø 1/10 (mm)		008	010	014	014	009	009	007	009	031	016	016	023	023	027	031	
Head Length (mm)		3	4	6	9		3.2	3	3.5	3.5	3.5	5	5.5	2.8	2.9	3.2	
		NEW	NEW		NEW	NEW	NEW		NEW	NEW	NEW		NEW				
FG 31	REGULAR	SUPER COARSE															
		COARSE															
		STANDARD	DET3	DET4	DET6	DET9			A22C	A21C							
		FINE	DET3F	DET4F	DET6F	DET9F	C18LF	A22LF	A22F	A21F	C20LF	C20SF	C20F		C18F	C19F	C19LF
		EXTRA FINE	DET3P	DET4P	DET6P	DET9P		A22LP	A22P	A21P							
33	ST	COARSE															
		STANDARD				MDEY6C											
				MDET6													

FG		GUIDE PIN			MICRO PREP				END CUTTER							
ISO No.		508	508	30006	838M	889M	830RM	830M	839	839	839	839	10839	10839		10839
ISO Shape No.									150	150	150	150				
ISO Ø 1/10 (mm)		016	020	020	007	007	009	012	010	012	014	016	012	014		016
Head Length (mm)		7.5	7.5	10	2.5	2.5	2.5	2.5								
FG 31	REGULAR	SUPER COARSE														
		COARSE														
		STANDARD	N4	N4L	N4LL	A19S	A22S	C12S3	C120	A18C	A18LC	A18LLC	A18L3C			
		FINE	N4F	N4LF						A18	A18L	A18LL	A18L3	A18R	A18R2	A18R3
		EXTRA FINE								A18F						

DIAMOND GRIT SIZES

- **STANDARD GRIT**
105 – 125 µm
- **COARSE GRIT**
150 µm
- **SUPER COARSE GRIT**
180 µm
- **FINE GRIT**
55 µm
- **EXTRA FINE GRIT**
25 µm

SHANK SIZES

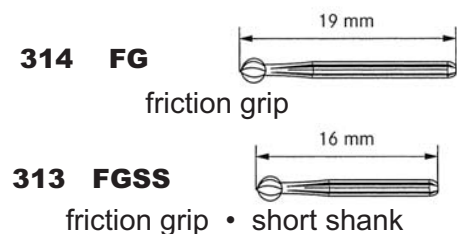



DIAMOND GRIT SIZES

- **STANDARD GRIT**
105 – 125 µm
- **COARSE GRIT**
150 µm
- **SUPER COARSE GRIT**
180 µm
- **FINE GRIT**
55 µm
- **EXTRA FINE GRIT**
25 µm

SHANK SIZES

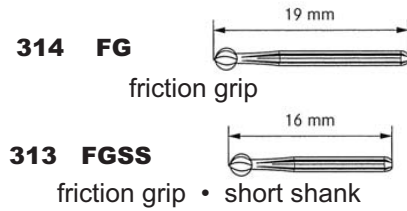

FG	ROUND END TAPER																	
ISO No.	856	856	856	856M	856	856	856	856	856L	856L	856L	850	850	850	850	850N	850L	
ISO Shape No.	198	198	198	198M	198	198	198	198	198L	198L	198L	199	199	199	199	198N	200	
ISO Ø 1/10 (mm)	012	014	016	016	018	021	025	029	014	016	021	012	014	016	018	016	018	
Head Length (mm)	8	8	8	8	8	8	8	8	9	9	10	10	10	10	10	10	12	
FG 31 REGULAR	SUPER COARSE	B5XC	B6SXC	B5MXC	B6MXC	B5LXC	D2SXC	D2XC		C3SSXC	B6LXC	D2LSXC	C4SXC	C4XC	C4MXC	C4LXC	C3XC	C5XC
	COARSE	B5C	B6SC	B5MC	B6MC	B5LC	D2SC	D2C		C3SSC	B6LC	D2LSC	C4SC	C4C	C4MC	C4LC	C3C	C5C
	STANDARD	B5	B6S	B5M	B6M	B5L	D2S	D2		C3SS	B6L	D2LS	C4S	C4	C4M	C4L	C3	C5
	FINE	B5F	B6SF	B5MF	B6MF	B5LF	D2SF	D2F		C3SSF	B6LF		C4SF	C4F	C4MF	C4LF	C3F	C5F
	EXTRA FINE	B5P		B5MP							B6LP						C4LP	C3P
	GOLD	GB5		GB5M	GB6M	GB5L		GD2			GB6L		GC4S	GC4	GC4M	GC4L	GC3	GC5
FG 33 SHORT	SUPER COARSE	MB5XC		MB5MXC		MB5LXC	MD2SXC	MD2XC		MC3SSXC	MB6LXC			MC4XC	MC4MXC			
	COARSE	MB5C		MB5MC		MB5LC	MD2SC	MD2C	MD3LC	MC3SSC	MB6LC			MC4C	MC4MC		MC3C	
	STANDARD	MB5		MB5M		MB5L	MD2S	MD2		MC3SS	MB6L			MC4	MC4M		MC3	
	GOLD										GMB6L						GMC3	
	GOLD / COARSE										GMB6LC						GMC3C	

All Crosstech Diamond Burs are Excellent for Cutting Zirconia in Crown Removal

- Use as much water spray as possible without impeding visibility.
- Use caution in the amount of pressure applied when cutting the zirconia to avoid damaging the underlying tooth structure
- Use a new diamond to make a clean cut on the buccal surface extending onto the occlusal or incisal surface.
- Use a crown removing instrument such as a crown spreader to fracture the crown and/or break the cement layer.

FG	ROUND END TAPER									ROUND END CYLINDER								
ISO No.	850	850N	849L	855	855	855	856N	855	855	835KR	835KR	835KR	835KR	835KR	836KR	836KR	837KR	
ISO Shape No.	199	199N	198L	198	198	198	198N	198	198	156	156	156	156	156	156	156	158	
ISO Ø 1/10 (mm)	023	021	009	014	012	016	016	018	025	008	008	010	012	014	010	016	010	
Head Length (mm)	10	12	6	6	6	6	7	6	7	3	4.5	4	5	5	6	6	7	
FG 31 REGULAR	SUPER COARSE	C4LLXC	C3LXC		B5MSSXC	B5SXC	B5MSXC		D3SXC	D3XC						B1SSXC		
	COARSE	C4LLC	C3LC	B5SSC	B5MSSC	B5S	B5MSC	B6C	D3S	D3C		A19LC	A20C	A20LC	A20LLC	B1SSC		B1SSRC
	STANDARD	C4LL	C3L	B5SS	B5MSS	B5S	B5MS	B6	D3S	D3	A19	A19L	A20	A20L	A20LL	B1SS	A20L3	
	FINE					B5SF	B5MSF	B6F	D3SF		A19F		A20F	A20LF	A20LLF	B1SSF		B1SSRF
	EXTRA FINE							B6P					A20P			B1SSP		
	GOLD		GC3L					GB6		GD3	GA19		GA20			GB1SS		
FG 33 SHORT	SUPER COARSE				MB5MSSXC				MB6XC									
	COARSE				MB5MSSC				MB6C		MA19LC							
	STANDARD				MB5MSS				MB6									



DIAMOND BURS

FRAISES DIAMANTÉES



FG		ROUND END CYLINDER							KS SERIES						ENDO				
ISO No.		837KR	837KR	837KR	838	838	880	882	KS0	KS1	KS2	KS3	KS4	KS5	802L	802L	802L	802L	
ISO Shape No.		158	158	158			140								005	005	005	005	
ISO Ø 1/10 (mm)		012	014	016	010	012	014	014	010	012	014	016	024	031	018	018	012	014	
Head Length (mm)		7	7	8	4	4	6	12	7	7	8	8	4	6	7.5	9	10	10	
		NEW	NEW	NEW	NEW	NEW		NEW	NEW					NEW	NEW				
FG 31	REGULAR	SUPER COARSE						B2XC	B2SSXC	B2SXC	B2MXC	B2LXC		KS5XC					
		COARSE	B1SRC	B1RC	B1LRC		A20LRC	B2C	B2MLC	B2SSC	B2SC	B2MC	B2LC			N3C	N3LC	N3SSC	N3SC
		STANDARD	B1SR	B1R	B1LR	A20R	A20LR	B2		B2SS	B2S	B2M	B2L			N3	N3L	N3SS	N3S
		FINE	B1SRF	B1RF			A20LRF	B2F		B2SSF	B2SF	B2MF		KS4F					
		EXTRA FINE						B2P											
		GOLD						GB2							GN3				
FG33	SHRT	SUPER COARSE						MB2XC											
		COARSE						MB2C											
		STANDARD						MB2											

FG		ENDO		ENDO (SAFE END)					MODIFIED SHOULDER									
ISO No.		802L	802L	861K	851	857	863K	857	857	845KR	845KR	846KR	846KR	846KR	847KR	847KR	847KR	
ISO Shape No.		005	005	219	219	219	220	220	220	168KR	168KR	168KR	168KR	168KR	172KR	172KR	172KR	
ISO Ø 1/10 (mm)		016	018	012	012	016	012	014	016	018	025	016	018	023	016	018	023	
Head Length (mm)		10	10	6	8	7	10	10	10	4	4	6	6	6	8	8	8	
												NEW	NEW	NEW			NEW	
FG 31	REGULAR	SUPER COARSE								A16RLXC	A16RLLXC				B4RXC	B4LRXC		
		COARSE	N3MC	N3LLC	N1SSC	N1SC	N1C	N1MC	N2SC	N2C	A16RLC	A16RLLC	A16RC	A163C	A164C	B4RC	B4LRC	D9RC
		STANDARD	N3M	N3LL	N1SS	N1S	N1	N1M	N2S	N2	A16RL	A16RLL	A16R		A164	B4R	B4LR	D9R
		FINE			N1SSF	N1SF		N1MF				A16RLLF	A16RF	A163F	A164F	B4RF	B4LRF	
		EXTRA FINE			N1SSP			N1MP										
		GOLD					GN1		GN2									
FG33	SHRT	SUPER COARSE													MB4RXC	MB4LRXC		
		COARSE										MA16RC			MB4RC	MB4LRC		
		STANDARD										MA16R			MB4R	MB4LR		
	FINE										MA16RF							

FG		FLAT END SHOULDER																
ISO No.		845	845	845	846	846	846	847	847	847	847	848	848	848	848	848L	848	
ISO Shape No.		168	168	168	171	171	171	172	172	172	172	173	173	173	173	174	173	
ISO Ø 1/10 (mm)		011	014	016	012	016	025	012	014	016	018	012	014	016	018	018	023	
Head Length (mm)		4	4	4.5	6	6	7	8	8	8	8	10	10	10	10	12	9	
			NEW		NEW	NEW	NEW		NEW	NEW					NEW		NEW	
FG 31	REGULAR	SUPER COARSE			B3SXC	B4SSXC	D10XC	B4SXC	BB3XC	BB4XC	B4LXC		C2SXC	C2XC	C2MXC	C2LXC	D9XC	
		COARSE	A15C	A16SC	A16C	B3SC	B4SSC	D10C	B4SC	BB3C	BB4C	B4LC	C1C	C2SC	C2C	C2MC	C2LC	D9C
		STANDARD	A15	A16S	A16	B3S	B4SS	D10	B4S	BB3	BB4	B4L	C1	C2S	C2	C2M	C2L	D9
		FINE							B4SF	BB3F	BB4F	B4LF	C1F	C2SF	C2F			
		EXTRA FINE			A16P							B4LP		C2SP				
		GOLD	GA15		GA16							GB4L	GC1	GC2S	GC2		GC2L	
FG33	SHORT	SUPER COARSE						MB4SXC	MBB3XC	MBB4XC	MB4LXC		MC2SXC	MC2XC				
		COARSE	MA15C		MA16C			MB4SC	MBB3C	MBB4C	MB4LC		MC2SC	MC2C				
		STANDARD	MA15		MA16			MB4S	MBB3	MBB4	MB4L		MC2S	MC2				
		GOLD	GMA15		GMA16								GMC2S					
	GOLD/COARSE	GMA15C		GMA16C								GMC2SC						



FG		FLAT END CYLINDER																		
ISO No.		835	835	835	835	835	835	835	835	835	837	836	836	837	837	837L	837L	837L	842	
ISO Shape No.		107	107	107	107	107	107	107	107	107	110	107	107	110	110	110L	110L	110L		
ISO Ø 1/10 (mm)		008	008	009	010	012	012	014	014	016	010	012	014	016	018	012	016	018	014	
Head Length (mm)		3.5	4.5	3	4	4	5	4	5	4	8	7	7	8	8	10	10	10	12	
											NEW					NEW	NEW	NEW	NEW	
FG 31	REGULAR	SUPER COARSE				A13SXC	A13XC			A14XC						B1SXC	B1XC	B1LXC	B1LLXC	
		COARSE	A12C	A12LC	A13SSC	A13SC	A13C	A13LC	A14C	A14LC	A14MC	A13SLC	B1SC	B1C	B1LC	B1LLC	B1MC	B1NC	B1QC	B1L3C
		STANDARD	A12	A12L	A13SS	A13S	A13	A13L	A14	A14L	A14M		B1S	B1	B1L	B1LL				
		FINE	A12F			A13SF	A13F		A14F			A13SLF	B1SF	B1F						
		EXTRA FINE																		
		GOLD	GA12					GA13		GA14				GB1S	GB1					
	GOLD / COARSE	GA12C					GA13C		GA14C				GB1SC	GB1C						
	GOLD/FINE						GA13F		GA14F				GB1SF	GB1F						
FG33	SHORT	SUPER COARSE					MA13XC		MA14XC							MB1XC				
		COARSE				MA13SC	MA13C		MA14C							MB1C				
		STANDARD	MA12			MA13S	MA13		MA14							MB1				
		GOLD	GMA12				GMA13		GMA14							GMB1				
		GOLD / COARSE														GMB1C				

FG		ROUND													ROUND W/Surgical L.						
ISO No.		801	801	801	801	801	801	801	801	801	801	801	801	801	801L	801L	801L	801L	801L		
ISO Shape No.		001	001	001	001	001	001	001	001	001	001	001	001	001	001	001	001	001	001		
ISO Ø 1/10 (mm)		008	009	010	012	014	016	018	021	023	029	033	035	009	012	014	016	018			
Head Length (mm)																					
FG 31	REGULAR	SUPER COARSE						A3XC	A4XC	A5XC	A5LXC	A5LLXC						ALL3SXC		ALL4XC	
		COARSE	A0C	A1C	A2SC	A2C	A2LC	A3C	A4C	A5C	A5LC	A5LLC	A5L3C					ALL2C	ALL3SC	ALL3C	ALL4C
		STANDARD	A0	A1	A2S	A2	A2L	A3	A4	A5	A5L	A5LL		A5L4	ALL1	ALL2	ALL3S	ALL3	ALL4		
		FINE			A2SF	A2F	A2LF	A3F	A4F	A5F	A5LF	A5LLF	A5L3F								
		EXTRA FINE						A3P		A5P	A5LP										
		GOLD		GA1		GA2		GA3	GA4	GA5											
	GOLD / COARSE		GA1C		GA2C		GA3C	GA4C	GA5C												
	GOLD/FINE				GA2F		GA3F	GA4F	GA5F												
FG33	SHORT	SUPER COARSE																			
		COARSE		MA1C		MA2C		MA3C													
		STANDARD		MA1		MA2		MA3													

FG		ROUND W/S. L.		DOUBLE INVERTED CONE								WHEEL								
ISO No.		801L	801L	806	806	806	806	806	806	813	813	909	909	909	909	909	825	825		
ISO Shape No.		001	001	019	019	019	019	019	019			068	068	068	068	068				
ISO Ø 1/10 (mm)		021	023	009	010	012	014	016	018	014	016	035	040	045	045	052	016	023		
Head Length (mm)				2.2	2.2	2.7	3.5	3.5	3.5			1.2	1	1.0	1.7	2.5				
						NEW				NEW	NEW			NEW			NEW	NEW	NEW	
FG 31	REGULAR	SUPER COARSE	ALL5XC	ALL5MXC														C14XC		
		COARSE	ALL5C	ALL5MC		A9C	A10SSC	A10C	A10LC	A10LLC	A10SC	A10LSC	C14SSC		C14SC	C14C	C142C			
		STANDARD	ALL5	ALL5M	A9S	A9	A10SS	A10	A10L	A10LL	A10S	A10LS	C14SS	C141	C14S	C14	C142	C144	C145	
		EXTRA FINE	ALL5P																	
		GOLD			GA9S	GA9		GA10										GC14		
	GOLD / COARSE																GC14C			
FG33	SHORT	SUPER COARSE																MC14XC		
		COARSE																MC14C		
		STANDARD				MA9		MA10										MC14		

DIAMOND BURS



FRAISES DIAMANTÉES

FG		OCCLUSAL REDUCTION						AXIAL REDUCTION				DEPTH CUTTER					
ISO No.		828	828	828	828	828	828					828	834	834	834	868A	868A
ISO Shape No.																	
ISO Ø 1/10 (mm)		017	017	017	017	017	017	008	008	008	008	026	016	021	031	018	021
Head Length (mm)		1.2	1.5	1.8	2.0	2.2	2.4	0.6	1.0	1.5	2.0	D:0.5	D:0.3	D:0.5	D:1.0	D:0.3	D:0.4
														NEW	NEW	NEW	NEW
FG 31	SUPER COARSE																
	COARSE	E10C	E11C	E12C	E13C	E14C	E15C	M1C	M2C	M3C	M4C	D7S2C	D7SC	D7MC			
	STANDARD	E10	E11	E12	E13	E14	E15	M1	M2	M3	M4	D7S2	D7S	D7M	D7L	D71	D72
	FINE							M1F	M2F	M3F	M4F						
	EXTRA FINE																
	GOLD																

FG		MODIFIED BEVELED CYLINDER												BEVELED CYLINDER					
ISO No.		877	877	877	878	878	878	878	879	879	879	879	879L	884	884	885	885	885	886
ISO Shape No.		288	288	288	289	289	289	289	290	290	290	290	290	129	129	130	130	130	131
ISO Ø 1/10 (mm)		010	012	014	010	012	014	016	012	014	016	018	012	012	014	010	012	014	010
Head Length (mm)		6	6	6	8	8	8	8	10	10	10	10	12	6	6	8	8	8	10
									NEW	NEW	NEW	NEW	NEW	NEW	NEW	NEW	NEW	NEW	
FG 31	SUPER COARSE					B11XC	B11MXC	B11LXC	C22XC	C23XC	C24XC	C25XC	C26XC					B15XC	B16XC
	COARSE	B10C	B10MC	B10LC	B11SC	B11C	B11MC	B11LC	C22C	C23C	C24C	C25C	C26C	B12C	B13C	B14C	B15C	B16C	C9SSC
	STANDARD	B10	B10M	B10L	B11S	B11	B11M	B11L	C22	C23	C24	C25	C26	B12	B13	B14	B15	B16	C9SS
	FINE	B10F	B10MF	B10LF	B11SF	B11F	B11MF	B11LF	C22F	C23F	C24F	C25F	C26F	B12F	B13F	B14F	B15F	B16F	C9SSF
	EXTRA FINE	B10P																	
	GOLD	GB10				GB11													
	GOLD / COARSE	GB10C				GB11C													
	GOLD/FINE	GB10F				GB11F													
FG33 SHORT	SUPER COARS					MB11X													
	COARSE					MB11C													
	STANDARD					MB11													

FG		BEVELED CYLINDER			MODIFIED CHAMFER													
ISO No.		886	886	886	876K	877K	877K	877K	877K	877K	878K	878K	878K	878K	878K	878K	878K	879K
ISO Shape No.		131	131	131	297	297	297	297	297	298	298	298	298	298	298	298	298	298
ISO Ø 1/10 (mm)		012	014	016	012	012	014	016	018	021	012	014	016	018	021	023	017	012
Head Length (mm)		10	10	10	4	6	6	6	6	6	8	8	8	8	8	8	9	10
FG 31	SUPER COARSE	C9SXC	C9XC	C9LXC			S2SXXC	S2MSXC	S2LSXC	S2LLSXC	S2SXC	S2XC	S2MXC	S2LXC	S2LLXC	S4XC	S1XC	S3SXC
	COARSE	C9SC	C9C	C9LC	S2S4C	S2S3C	S2SSC	S2MSC	S2LSC	S2LLSC	S2SC	S2C	S2MC	S2LC	S2LLC	S4C	S1C	S3SSC
	STANDARD	C9S	C9	C9L	S2S4	S2S3	S2SS	S2MS	S2LS	S2LLS	S2S	S2	S2M	S2L	S2LL	S4	S1	S3SS
	FINE	C9SF	C9F	C9LF		S2S3F	S2SSF		S2LSF			S2F	S2MF	S2LF		S4F	S1F	
	EXTRA FINE								S2LSXC				S2MP				S1P	
	GOLD		GC9	GC9L								GS2	GS2M	GS2L			GS1	
	GOLD / COARSE		GC9C	GC9LC								GS2C	GS2MC	GS2LC				
	GOLD/FINE		GC9F	GC9LF								GS2MF						
FG33 SHIRT	SUPER COARSE		MC9XC	MC9LXC							MS2SXC	MS2XC	MS2MXC	MS2LXC	MS2LLXC			
	COARSE		MC9C	MC9LC				MS2MSC			MS2SC	MS2C	MS2MC	MS2LC	MS2LLC			
	STANDARD		MC9	MC9L				MS2MS			MS2S	MS2	MS2M	MS2L	MS2LL			
	GOLD		GMC9	GMC9L														
	GOLD / COARSE		GMC9C	GMC9LC														



FG	MODIFIED CHAMFER				INVERTED CONE											ROUND W/COLLAR			
ISO No.	879K	879K	879K	879K	805	805	805	805	805	805	805	805	807	807	807	807	802	802	802
ISO Shape No.	298	298	298	298	010	010	010	010	010	010	010	010	225	225	225	225	002	002	002
ISO Ø 1/10 (mm)	014	016	018	021	010	012	014	016	018	021	023	023	012	014	016	018	009	012	016
Head Length (mm)	10	10	10	10	1	1.5	1.5	1.8	1.8	1.8	2.3	3.5	3.5	3.5	3.5	5	3	3	3.3
FG 31 REGULAR	SUPER COARSE	S3SXC	S3XC	S3LXC	S5XC			A8XC	A8MXC	A8LXC	A8LLXC	A8L3XC		A11LXC	A11LLXC	A11L3XC			AL3XC
	COARSE	S3SC	S3C	S3LC	S5C	A6C	A7C	A8C	A8MC	A8LC	A8LLC	A8L3C	A11C	A11LC	A11LLC	A11L3C	AL1C	AL2C	AL3C
	STANDARD	S3S	S3	S3L	S5	A6	A7	A8	A8M	A8L	A8LL	A8L3	A11	A11L	A11LL	A11L3	AL1	AL2	AL3
	FINE		S3F	S3LF				A8F											
	EXTRA FINE																		
	GOLD		GS3	GS3L		GA6	GA7	GA8					GA11				GAL1	GAL2	GAL3
	GOLD / COARSE		GS3C	GS3LC		GA6C	GA7C	GA8C					GA11C						
GOLD/FINE		GS3F	GS3LF																
FG33 SHORT	SUPER COARS							MA8XC											
	COARSE						MA7C	MA8C											
	STANDARD					MA6	MA7	MA8									MAL1	MAL2	MAL3

FG	PEAR														BULK REDUCTION				
ISO No.	830	830	830	830	830	830	830	830	830	830L	830L	830L	830L	830L	830L	6055	6051		
ISO Shape No.	234	234	234	234	234	234	234	234	234	234	234	234	234	234	234				
ISO Ø 1/10 (mm)	008	012	008	010	012	014	016	018	010	012	016	018	021	032		018	018		
Head Length (mm)	1.6	1.7	2.5	2.7	2.6	2.6	2.7	2.8	4	4	5	5	5	5	5	8	8		
			NEW	NEW			NEW	NEW	NEW				NEW						
FG 31 REGULAR	SUPER COARSE															C12XC	C16XC	D1XC	D1LXC
	COARSE	C12S4C	C12SSMC		C12NC	C12S2C	C12MC		C12SNC	C12SSC	C12SSC	C12SC	C12SMC	C12C	C16C	D1C	D1LC		
	STANDARD	C12S4	C12SSM	D245	C12N	C12S2	C12M	C12ML	C12SN	C12SSS	C12SS	C12S	C12SM	C12	C16	D1	D1L		
	FINE	C12S4F	C12SSMF			C12S2F				C12SSSF	C12SSF	C12SF				C12F	C16F		
	EXTRA FINE										C12SSP					C12P	C16P		
	GOLD															GC12	GC16	GD1	
GOLD / COARSE															GC12C	GC16C	GD1C		
FG31 SHORT	SUPER COARSE															MC12XC			
	COARSE		MC12SSMC			MC12S2C										MC12C			
	STANDARD	MC12S4	MC12SSM			MC12S2										MC12			

FG	FOOTBALL				EGG						ROUND TIP			
ISO No.	368	368	368	368	379	379	379	379	379	379	390	390	390	
ISO Shape No.	257	257	257	257	277	277	277	277	277	277	274	274	274	
ISO Ø 1/10 (mm)	016	018	021	023	012	014	016	018	021	023	010	014	016	
Head Length (mm)	3.5	4.5	5	5	2.8	2.8	3.4	3.4	3.8	5	3	3	3.5	
			NEW											
REGULAR	SUPER COARSE	A17SXC	A173XC		C15XC				C15RSXC	C15RMSXC	C15RXC			
	COARSE	A17SC	A173C	C15SC	C15C	C15RS3C	C15RSSC	C15RS1C	C15RSC	C15RMSC	C15RC			
	STANDARD	A17S	A173	C15S	C15	C15RS3	C15RSS	C15RS1	C15RS	C15RMS	C15R	A23	A24	C21
	FINE	A17SF	A173F	C15SF	C15F	C15RS3F	C15RSSF	C15RS1F	C15RSF	C15RMSF	C15RF	A23F	A24F	C21F
	EXTRA FINE	A17SP	A173P		C15P		C15RSSP	C15RS1P	C15RSP		C15RP	A23P	A24P	C21P
	GOLD	GA17S			GC15						GC15R			
	GOLD / COARSE	GA17SC			GC15C						GC15RC			
GOLD/FINE	GA17SF			GC15F						GC15RF				
SHORT	SUPER COARSE										MC15RXC			
	COARSE										MC15RC			
	STANDARD										MC15R			

DIAMOND BURS



FRAISES DIAMANTÉES

FG	FLAME																	
ISO No.	30011	862	862	888	862	888	30011	862	863	863L	863	862L	30011	860	860	860	860	
ISO Shape No.	052	249	249	249	249	249	056	249	250	250L	250	249	055	247	247	247	247	
ISO Ø 1/10 (mm)	012	010	012	012	014	014	014	016	012	014	016	018	020	010	012	014	016	
Head Length (mm)	6.5	8	8	8	8	8	8.0	8	10	12	10	9	9	4	4	4	4	
		NEW		NEW				NEW	NEW				NEW					
FG 31 REGULAR	SUPER COARSE			B9SSXC	B8XC	B9LXC	B9XC		B9MXC	C10XC	C10LXC	C11XC	B9LLXC					
	COARSE	B8SSC	B8SC	B9SSC	B8C	B9LC	B9C	B9SC	B9MC	C10C	C10LC	C11C	B9LLC	B9L3C	A25C	A26C	A27C	A28C
	STANDARD	B8SS	B8S	B9SS	B8	B9L	B9	B9S	B9M	C10	C10L	C11	B9LL	B9L3	A25	A26	A27	A28
	FINE	B8SSF	B8SF	B9SSF	B8F	B9LF	B9F	B9SF	B9MF	C10F	C10LF	C11F	B9LLF	B9L3F	A25F	A26F	A27F	A28F
	EXTRA FINE	B8SSP	B8SP	B9SSP	B8P	B9LP	B9P		B9MP	C10P		C11P			A25P	A26P		A28P
	GOLD				GB8			GB9		GC10		GC11						
	GOLD / COARSE				GB8C			GB9C		GC10C		GC11C						
GOLD/FINE				GB8F			GB9F		GC10F		GC11F							
FG33 SHRT	SUPER COARSE			MB9SSXC	MB8XC			MB9XC		MB9MXC								
	COARSE			MB9SSC	MB8C	MB9LC	MB9C		MB9MC									
	STANDARD			MB9SS	MB8	MB9L	MB9		MB9M									
	FINE			MB9SSF		MB9LF			MB9MF									

FG	BARREL				NEEDLES												SPIRAL	
ISO No.	811	811	811	811	852	852	858	858	858	858	858	859	859	859	859	859	859	848
ISO Shape No.	038	038	038	038	160	160	164	164	164	164	166	166	166	166	166	166	173	
ISO Ø 1/10 (mm)	017	032	038	047	008	012	010	012	014	016	011	010	014	016	018	021	016	
Head Length (mm)	4	5	6	7	6	6	8	8	8	8	9	11	10	10	10	10	10	
				NEW								NEW						
FG 31 REGULAR	SUPER COARSE		C13XC	C13LXC					B7XC	B7LXC			C7SXC		C8XC	C8LXC	D6XC	
	COARSE	C17C	C13C	C13LC	C13LLC				B7SC	B7C	B7LC	C6C		C7SC	C7C	C8C	C8LC	D6C
	STANDARD	C17	C13	C13L		B71	B73	C6S	B7S	B7	B7L	C6	C6L	C7S	C7	C8	C8L	D6
	FINE		C13F			B71F	B73F	C6SF	B7SF	B7F	B7LF	C6F	C6LF	C7SF	C7F	C8F	C8LF	
	EXTRA FINE					B71P	B73P		B7SP	B7P		C6P		C7SP	C7P	C8P		
	GOLD		GC13						GB7S	GB7		GC6			GC7	GC8		
GOLD / COARSE		GC13C							GB7C		GC6C			GC7C	GC8C			
GOLD/FINE								GB7SF	GB7F		GC6F			GC7F	GC8F			
FG33 SHRT	SUPER COARSE								MB7XC	MB7LXC				MC7XC				
	COARSE								MB7C	MB7LC				MC7C				
	STANDARD								MB7	MB7L				MC7				
	GOLD								GMB7					GMC7				
	GOLD / COARSE								GMB7C					GMC7C				

RA DIAMONDS

FG																	
ISO No.	801	801	801	801	802	802	802	805	807	835	835	856	856L	858	862	878K	848
ISO Shape No.	001	001	001	001	002	002	002	010	225	107	107	198	198	164	249	298	173
ISO Ø 1/10 (mm)	009	012	016	021	009	012	016	012	014	008	013	012	016	012	014	014	016
Head Length (mm)					3	3	3.5	1.5	3.5	3.5	4.5	8	9	6	7.5	8	10
STANDARD	RA1-D	RA2-D	RA3-D	RA5-D	RAL1	RAL2	RAL3	RA7-D	RA11L	RA12	RA14	RB5	RB6L	RB7S	RB9	RS2	RC2S



TURBO DIAMONDS

Crosstech Turbo Diamonds incorporate diamond-free cooling zones that absorb normal heat generation, resulting in fast reduction while remaining cool.

FG	FLAT END TAPER					ROUND END TAPER						FLAME			
ISO No.	847	847	847	848	847KR	856	856	856	850	856L	856	862	862	863	
ISO Shape No.	172	172	172	173	172KR	198	198	198	198	198L	198	249	249	250	
ISO Ø 1/10 (mm)	014	016	018	018	016	014	012	016	018	021	025	012	014	016	
Head Length (mm)	8	8	8	10	8	8	8	8	10	10	8	8	8	8	
REG	SUPER COARSE	TBB3XC	TBB4XC	TB4LXC	TC2XC	TB4RXC	TB6SXC	TB5XC	TB6MXC	TC4LXC	TD2LSXC	TD2XC	TB9SSXC	TB9LXC	TC11XC
	COARSE			TB4LC	TC2C				TB6MC	TC4LC	TD2LSC	TD2C			
SHRT	SUPER COARSE			MTB4LXC	MTC2XC		MTB6SXC	MTB5XC	MTB6MXC	MTC4LXC	MTD2LSXC	MTD2XC			
	COARSE			MTB4LC	MTC2C				MTB6MC	MTC4LC	MTD2LSC	MTD2C			

FG	MODIFIED CHAMFER						FLAT END CYLINDER			BEVELED CYLINDER			BARREL	FOOTBALL	
ISO No.	878K	878K	878K	878K	879K	878K	837KR	837KR	837	885	878	879	811	368	
ISO Shape No.	298	298	298	298	299	298	158	158	158	130	289	290		257	
ISO Ø 1/10 (mm)	014	016	017	018	018	021	012	014	016	012	014	016	033	023	
Head Length (mm)	8	8	9	8	10	8	8	8	8	8	8	10	5	5	
REG	SUPER COARSE	TS2XC	TS2MXC	TS1XC	TS2LXC	TS3LXC	TS2LLXC	TB1SRXC	TB1RXC	TB1LXC	TB15XC	TB11MXC	TC24XC	TC13XC	TC15XC
	COARSE		TS2MC	TS1C	TS2LC	TS3LC	TS2LLC								TC15C
SHRT	SUPER COARSE		MTS2MXC	MTS1XC	MTS2LXC	MTS3LXC	MTS2LLXC		MTB1RXC						MTC15XC
	COARSE		MTS2MC	MTS1C	MTS2LC	MTS3LC	MTS2LLC								MTC15C

LAB BURS
FRAISES DE LABORATOIRE



ROBOT DIAMOND BURS
FRAISES DIAMANTÉES



Each | Chaque
Code: 04-115

\$ 16.80

Each | Chaque
Code: 04-116

\$ 38.31

BUR BLOCK
PORTES FRAISES



Magnetic Bur block
Porte fraises magnétique

24 holes | 24 trous
Code: 04-117

\$ 7.30



Aluminum Bur block
Porte fraises aluminium

10 FG / 5 RA
Code: 04-118

\$ 29.00

CAVIT™



Cavit G
28gm. jar | Pot 28gm.
Code: 05-101

\$ 24.44

Cavit P
28gm. jar | Pot 28gm.
Code: 05-102

\$ 24.44



MD-TEMP PLUS



White OR Pink | Blanc OU Rose
40gm. jar | Pot 40gm.
Code: 05-103

\$10.67

INTERVAL® LC



Light cure temporary filling



Plombage provisoire photopolymérisable

4.5gm syringe | seringue 4.5gm.
Code: 05-104

\$ 22.99



ZONALIN



Powder | Poudre
28gm. jar | Pot 28gm.
Code: 05-107

\$ 22.00

Liquid | Liquide
10ml. bottle | bouteille 10ml
Code: 05-106

\$ 18.50

**ZINC OXIDE, USP
OXYDE DE ZINC**



1 lb.
Code: 05-108

\$ 25.97



IRM

Standard Package -
Powder(38g)
Liquid (14mL)



Paquet standard:
Poudre: 38gm.
Liquide: 14ml.

Code: 05-109

\$ 74.15

VITREBOND™



VITREBOND™ PLUS

Glass ionomer light cure base and cavity liner

9gm. powder
5.5ml. liquide



Code: 05-201

\$127.99

9gm. powder | poudre
Code: 05-202

\$ 93.80

Verre ionomère base et profondeur de cavité photopolymérisable
9gm. poudre
5.5ml. liquide

5.5ml. liquid | Liquide
Code: 05-203

\$ 69.60

2 clickers 10gm. each



2 distributeurs Clicker (10 g ch.),

Code: 05-204

\$360.00

DYCAL®



Dentin Ivory



DentineIvoire

1 Base (13g), 1 Catalyst I Catalyseur (11g)
Code: 05-205

\$ 51.95



GC FUJI LINING™ LC

Light cure glass ionomer cavity liner



Profondeur de cavité verre ionomère photopolymérisable

1 cartridge 7gm. I 1 cartouche (7g)
Code: 05-206

\$155.00

LIME-LITE™ ENHANCED



Light cure cavity liner with fluoride release



Profondeur de cavité photopolymérisable et distribution de fluorure

4 (1.2 ml) syringes + 8 tips
4(1.2ml.) seringues + 8 embouts
Code: 05-207

\$ 84.00

Non-Setting Calcium Hydroxide



Hydroxyde de calcium non durcissante

4 x 1.2ml. syringes - seringues
Code: 07-401

\$ 64.99

Copaliner^{MC}



Bosworth Company



Protects the dentin; penetrates, fills, and seals the tubuli.

Protège la dentine; pénètre, remplit et scelle les tubes

5oz / 14ml.
Code:05-501

\$ 21.91



IONOSEAL®

Light cure glass ionomer cavity liner



Profondeur de cavité en verre ionomère photopolymérisable

3 (2.5gm) syringes + access
3(2.5gm.) seringues + access.
Code: 05-208

\$211.00

KETAC™ BOND



Glass ionomer cavity liner radio-opaque

2 Powder 10 g each, Shade yellow, 1 Liquid 12 ml



Fond de cavité en verre ionomère radio-opaque

2 x 10gm poudre jaune
1 x 12ml. liquide

Double pack / Paquet double

\$154.67



LIFE®

Base of Calcium hydroxide indicated for direct and indirect pulp capping



Base d'hydroxyde de calcium indiquée comme un pulpe directe et indirecte

12gm Catalyst & Base

\$ 64.32

Core material mixing tip

Embouts mélangeurs pour matériaux de reconstitution coronaire



HP Short Mixing Tips, Brown, Flat End with Extra-Fine Intra-Oral Tips

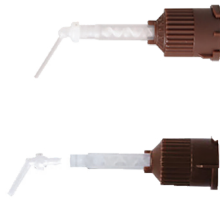

Embouts à mélanger bruns, avec extension intra-orale extra-fine.

30/pack - paquet
Code:05-607

\$ 42.70

Temporary cement mixing tips

Embouts mélangeurs pour cements provisoires

HP Short Mixing Tips, Brown, tapered



Embouts à mélanger bruns, conique

30/pack - paquet
Code:05-602

\$ 39.00

Premier CompCore SyringeMix mixing tip

Embouts mélangeurs CompCore SyringeMix



SyringeMix Extra-Fine Intraoral Tips XXF



SyringeMix embouts intra-orale XX Fine

50/pack - paquet
Code:05-603

\$ 39.70

Gc FujiCem 2 Mixing tip
Embouts mélangeurs pour FujiCem 2



Slide & Lock mixing tips for FujiCem 2



Slide & Lock embouts pour FujiCem 2

20/pack - paquet
Code:05-604

\$ 48.31

Mizzy PIP brushes
Pinceaux pour Mizzy PIP



12/pack - paquet
Code:05-605

\$ 15.73

Maxcem Elite mixing tips
Embouts mélangeurs pour Maxcem Elite



Mixing tips brown 4:1



Embouts bruns 4:1

50/pack - paquet
Code:05-606

\$ 92.13

CODE RINGS
ANNEAUX D'IDENTIFICATION



Silicon rings Autoclavable Standard 1/8"



En silicone Autoclavable Standard 1/8"

100/box - boîte
Code: 11-419

\$ 12.83

E-Z ID TAPE



Instruments identification tape. 10' x 1/4"



Ruban d'identification des instruments 10' x 1/4"

Refill 1 roll / Recharge 1 rouleau

\$ 13.95

MASKS

MASQUES

"Breathe E-Z" Dual Fit Ear-Loop Face Mask

MK-1246	Blue	Bleu
MK-1256	Pink	Rose
MK-1266	Lavender	Lavande

50/ Box - Boîte
Code: 06-101

\$ 14.50



Dual Fit Ear-Loop Face Masks (Pleated)

Level 1

Niveau 1

MK-7100	Blue	Bleu
MK-7110	Pink	Rose
MK-7120	White	Blanc

50/ Box - Boîte
Code: 06-102

\$ 16.95



Premium Ear-Loop Molded Mask

MK-1036	Blue	Bleu
MK-1066	Pink	Rose

50/ Box - Boîte
Code: 06-103

\$ 14.50

Dual Fit Ear-Loop Face Masks (Pleated) "Diffuser" Anti-Fog

Level 1

Niveau 1
Bleu

MK-1046	Blue	Bleu
MK-1056	Pink	Rose
MK-1076 (Tie-On)	Blue	Bleu

50/ Box - Boîte
Code: 06-104

\$ 14.50

Dual Fit Ear-Loop Face Masks (4-Pleat)

Level 2

Niveau 2

MK-7200	Blue	Bleu
MK-7210	Pink	Rose
MK-7220	White	Blanc

50/ Box - Boîte
Code: 06-106

\$ 19.50

Dual Fit Ear-Loop Face Masks (4-Pleat)

Level 3

Niveau 3

MK-7300	Blue	Bleu
MK-7310	Pink	Rose
MK-7320	White	Blanc

50/ Box - Boîte
Code: 06-107

\$ 21.50

Clear Protective eyewear Lunettes protectrices claires



Each / chaque
Code: 06-121

\$ 6.50

UV Protective eyewear Lunettes protectrices UV



Each / chaque
Code: 06-122

\$ 6.50

MASKS

MASQUES

MakRite N95 Masks (NIOSH approved)



20/ Box - Boîte
Code: 06-112

\$ 172.95

SAFE BASIC® PROCEDURAL MASKS (2131) Masques à procédure SAFE BASIC® (2131)



50/ Box - Boîte
Code: 06-113

\$ 17.95

SAFEMASK PREMIER LEVEL1 BLUE EARLOOP PREMIER SAFE MASK NIVEAU 1 avec boucles auriculaires bleu



50/ Box - Boîte
Code: 06-114

\$ 17.95



SafeMask® cone (2020) Masque SAFEMASK® conique (2020)



50/ Box - Boîte
Code: 06-115

\$ 17.95

SafeMask® SURGICAL TIE-ON LEVEL 1 SafeMask® Masque chirurgical avec lacets Niveau 1



50/ Box - Boîte
Code: 06-116

\$ 17.95

SafeMask® PREMIER ELITE LEVEL 3 MASKS MASQUES SafeMask® PREMIER ELITE NIVEAU 3



50/ Box - Boîte
Code: N/A MASK 3

\$ 23.95

LEVEL 1 MASKS EARLOOP BLUE MASQUES NIVEAU 1 BLEU avec boucles auriculaires



50/ Box - Boîte
Code: 06-120

\$ 14.95



LEVEL 3 MASKS EARLOOP BLUE MASQUES NIVEAU 3 BLEU avec boucles auriculaires



50/ Box - Boîte
Code: 06-119

\$ 19.95

MASKS

MASQUES

Extra-Safe Ear-Loop Mask (5330E) MASQUES EXTRA-SAFE

avec boucles auriculaires (5330E)



50/ Box - Boîte
Code: 06-117

\$ 14.50



Extra-Safe Sensitivr Ear-Loop Mask (5430E) MASQUES EXTRA-SAFE Sensitive

avec boucles auriculaires (5430E)



50/ Box - Boîte
Code: 06-118

\$ 16.95

INSTA-GARD MD MASKS LEVEL 3 MASQUES INSTA-GARD MD NIVEAU 3



Level 3
Anti-Fog foam surgical mask pleated with ties



Niveau 3
Masques chirurgicales mousse antibuée

AT74535
50/ Box - Boîte

\$ 29.95

INSTA-GARD MD MASKS LEVEL 1 MASQUES INSTA-GARD MD NIVEAU 1

Level 1
Earloop Yellow



Niveau 1
À boucles jaune

AT70021
50/ Box - Boîte

\$ 10.95

PROCEDURE MASK, PLEAT STYLE MASQUE DE PROCÉDURES, STYLE PLISSÉ



FLUIDSHIELD (SO SOFT)

Level 1
Earloop
3 plys
White



AT 47090
50/ Box - Boîte

\$ 11.95

Niveau 1
Avec boucles auriculaires
3 plis
Blanc

Level 1
With ties
3 plys
28802: Green
41805: White



50/ Box - Boîte

\$ 14.95

Niveau 1
Avec attaches
3 plis
28802: Vert
41805: Blanc

WI ORIENTAL KN95



907150
20/ Box - Boîte

\$ 17.95



KN95
Disposable Protective Face Mask

≥95%
Filtration rate

BOLISI KN95



BS-9502C
50/Box - Boîte

\$ 45.00

GLOVES

GANTS

DISTINCT LATEX POWDER FREE SANS POUDRE



VIBRANT LATEX POWDER FREE SANS POUDRE

Patented honeycomb
texture polymer coated



Texture alvéolée
brevetée. Recouverts
de polymère

Micro-textured finish



Fini micro-texturé

100/box - boîte
Code: 06-201

\$ 21.95

100/box - boîte
Code: 06-201

\$ 21.95

LATEX ULTRA-FIT SMOOTH LIGHTLY POWDERED LATEX ULTRA-FIT LISSE LÉGERMENT POUDRÉ



LATEX ULTRA-FIT TEXTURED POWDER-FREE LATEX ULTRA-FIT LISSE SANS POUDRE

Micro-textured finish

Fini micro-texturé



Micro-textured finish

Fini micro-texturé

100/box - boîte
Code: 06-206

\$ 13.95

100/box - boîte
Code: 06-207

\$ 14.95

Defend Micro Textured Latex gloves Gants micro-texturés en latex



Defend Nitrile Textured Gloves Gants en nitrile texturés

Powder free

Sans poudre



Powder free

Sans poudre



100/box - boîte
Code: 06-204

\$ 17.95

100/box - boîte
Code: 06-211

\$ 24.95

Halyard AquaSoft nitrile gloves Gants en nitrile AquaSoft



Premium latex gloves Gants en latex Premium

Powder free

Sans poudre



Powder free

Sans poudre

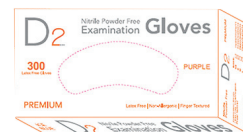

300/box - boîte
Code: 06-209

\$ 49.95

300/box - boîte
Code: 06-203

\$ 49.95

DEFEND TIE-BACK GOWN
ROBE AVEC RETENIR EN ARRIÈRE



Defend LAB COAT
BLOUSE DE LABORATOIRE

SG-1001
LARGE (48" length)



SG-1001
GRAND (48" longueur)

10/pack - paquet
Code: 06-301

\$ 39.50

SG-9005
LARGE / BLUE



SG-9005
GRAND / BLEU

10/pack - paquet
Code: 06-302

\$ 29.50

UNIPACK ISOLATION GOWN
BLOUSE ISOLANTE



BOUFFANT 21"
BOUFFANTE 21"

UGI-6719
Knit cuff pink



UGI-6719
Poignet à bourrelet rose

10/pack - paquet
Code: 06-304

\$ 39.95

UGA-6802
Sky blue



UGA-6802
Ciel blue

100/pack - paquet
Code: 06-307

\$ 11.00

ISOLATION GOWN - KNIT CUFF
BLOUSE ISOLANTE -
POIGNET À BOURRELET



EXTRA-SAFE LAB JACKET
BLOUSE DE LABORATOIRE EXTRA-SAFE

3260P
Knit cuff pink



3260P
Poignet à bourrelet rose

10/pack - paquet
Code: 06-305

\$17.95

3630LPM
Medium pink



3630LPM
Moyenne rose

10/pack - paquet
Code: 06-306

\$29.00

PLASTIC SHOE COVER
COUVRES CHAUSSEURS EN PLASTIQUE



POLYBACK BIBS
SERVIETTES POLYBACK

PCPRD2SHCO
Blue



PCPRD2SHCO
Bleu

100/pack - paquet
Code: 06-305

\$14.95

PP129-
Blue / Green / Dusty rose
lavander



PP129-
Bleu / Vert / Dusty rose
lavande

500/case - caisse
Code: 06-309

\$23.95

**PATIENT BIBS (2 PAPER / 1 POLY)
SERVIETTES (2 PAPIER / 1 POLY)**



**BIBS (NAPKIN) HOLDER
PORTES SERVIETTES**

1319
Blue/ White / Pink
Lavender / Green / Peach
Yellow



1319
Bleu / Blanc / Rose
Lavende / Vert / Pêche
Jaune

500/case - caisse
Code: 06-311

\$ 24.95

090
Silicon / autoclavable
Blue/ White / Red /
Yellow



090
Silicone / autoclavable
Bleu / Blanc / Rouge
Jaune

1/pack - paquet
Code: 06-312

\$ 4.95

**PLASTIC CUPS
VERRES EN PLASTIQUE**

PP-100-D2
Blue/ Green/ Lavender
Dusty rose / White
5oz.



PP-100-D2
Bleu / Vert / Rose
Lavende / Blanc
5oz.

1000/case - caisse
Code: 06-315

\$ 32.02

**SOLO CUPS
GOBELETS D'ÉVACUATION BUCCALE**

SOLO CUP
6oz.



SOLO CUP
6Ooz.

250/pack - paquet
Code: 06-316

\$ 30.48

DRI-ANGLE®



Cotton Roll Alternative

Plain / Silver coated
Small 400/box
Large 320/box



Alternatifs de rouleaux
de coton
Plain / Plaqués argent
Petit 400/boîte
Grand 320/boîte

Code: 06-317

Plain / Plain

\$ 19.67

Silver / Argent

\$ 25.95

MICROCOPY NEODRYS®

Cotton Roll Alternative

Plain / Silver coated
Small (yellow)
Large (blue)



Alternatifs de rouleaux
de coton
Plain / Plaqués argent
Petit jaune
Grand bleu

50/box - boîte
Code: 06-317

\$ 20.79

**COTTON ROLLS
ROULEAUX DE COTON**

CP105
1.5"x 3/8"



CP105
1.5"x 3/8"

2000/box- boîte
Code: 06-319

\$ 18.00



**COTTON TIP APPLICATOR
TIGE DE COTON**

CP104-3P
3" long

CP104-6P
6" long



CP104-3P
3" longe

CP104-6P
6" longue

Code: 06-323 (3')

\$ 6.95

1000/box- boîte

Code: 06-324 (6')

\$ 8.95

GAUZE ÉPONGES

Non sterile
Non woven
4 plys



Non stérile
Non tissées
4 plis

2' x 2'
CP101P
5000/case - caisse
Code: 06-321

4' x 4'
CP102P
2000/case - caisse
Code: 06-322

\$ 29.95

\$ 43.95



**GLASS DAPPEN DISH
GOGETS DAPPEN EN VERRE**

Clear
Blue
Green



Clair
Bleu
Vert

Each- Chaque
Code: 06-333

\$ 8.50

**MICRO APPLICATOR BRUSHES
PINCEAUX MICRO APPLICATEURS**

9115-RA Regular, Assorted
9118-FA Fine Assorted,
Yellow and Pink
9119-SW Super Fine, White
9014-XS Extra Slim, Black



9115-RA Régulier assortis
9118-FA Fine assortis,
jaune et rose
9119-SW Super Fine, Blanc
9014-XS Extra Slim, Noir

400/box- boîte
Code: 06-325

\$ 27.80



**RETAINER BOX / DENTURE BOX
BOÎTE DE PROTHÈSES / APPARIELS**

Assorted
colors



Couleurs
assortis

12/sac - sachet
Code: 06-334

\$13.65

**DISPOSABLE MIXING WELLS
GOGETS MÉLANGEURS JETABLES**

0002 2-well Design
200/box
0004 4-well Design
200/box



0002 2-godets ens.
200/boîte
0004 4-godets ens.
200/boîte

200/box- boîte
Code: 06-327 / Code: 06-328

\$ 25.56



**DISPOSABLE DAPPEN DISHES
GOGETS DAPPEN JETABLES**

0040 Assorted colors
Blue / White / Yellow /
Pink



0040 Couleurs assortis
Bleu / Blanc / Jaune
Rose

1000/box- boîte
Code: 06-332

\$ 48.00

MIXING TIP | EMBOUTS MÉLANGEURS

1412 Yellow / Jaune
4.2 mm
1413 ...Green / Vert
6.5 mm
1416 ...Purple / Mauve
7.5 mm
1417....Pink / Rose
5.0 mm



Code: 10-611
48/pk - pqt.

\$ 38.00

1418 Blue 1:10 C&B Temp. cement
Bleu 1:10 Ciment Temp. C&B
Code: 01-119
25/pk - pqt.

\$ 22.95

Intra-oral tips
Embouts intra-buccales
0059 Clear / Clair
0060 Yellow / Jaune
Code: 01-119
100/pk - pqt.

\$ 22.50



Pre-bent dispensing tips
Embouts applicateurs pré-courbés
2270 Pink Rose 18 ga.
2280 Yellow Jaune 20 ga.
2290 Black Noir 19 ga.
2300 Gray Gris 22 ga.
2310 Blue Bleu 25 ga.
Code 06-335
100/pk - pqt.

\$ 12.50

DISPOSABLES

JETABLES

APPLI-VAC™ TIPS bendable EMBOUTS APPLI-VAC™ pliables

315120
3/4" luer lock
Bendable
20G yellow



315120
3/4" luer lock
pliables
20G jaune

100/pack - paquet
Code: 06-336

\$ 29.78

APPLI-VAC™ IRRIGATION TIPS EMBOUTS D'IRRIGATION APPLI-VAC™

315530
1" luer lock
30G blue



315530
1" luer lock
30G bleu

100/pack - paquet
Code: 06-3361

\$ 34.38

DENTO-INFUSOR® TIP EMBOUTS DENTO-INFUSOR®

ULTRADENT
PRODUCTS, INC.

2259 Metal
Unique shape and
brush end tip
For use with hemostatic
solutions



2259 Métal
Form unique avec
pinceau à la fin.
Pour utiliser avec
les solutions
hémostatiques

100/pack - paquet
Code: 06-337

\$118.76

PALMERO
HEALTH CARE

MIXING PAD BLOC DE MÉLANGE



06-341	2 3/8" X 1 7/8"	60/SHEETS /PAD	\$ 2.50
06-342	3" X 3"	100 SHEETS /PAD	\$ 3.99
06-343	3" X 5"	100 SHEETS /PAD	\$ 5.00
06-344	5" X 8"	300 SHEETS /PAD	\$12.95
06-345	6" X 6"	100 SHEETS /PAD	\$ 4.50

BRUSH TIP EMBOUTS DE PINCEAU

BR
Refill



BR
Recharge

100/pack - paquet
Code: 06-347

\$11.50

PULPDENT® PIC-N-STIC™ APPLICATORS Dental Innovation Since 1947 APPLICATEURS PIC-N-STIC™

PIC
Length: 2 1/2"
Diameter: 2mm.
With adhesive at the
tip



PIC
2 1/2" longe
2mm. diamètre
Avec adhésif au bout

60/pack - paquet
Code: 06-348

\$27.53

SHARP CONTAINER CONTENANTS POUR OBJETS POINTUS

8881-676236
4 / 8 14 quart
red



8881-676236
1 gallon
rouge

Code: 06-346

Small 4 quart

\$ 6.95

Medium 8 quarts

\$ 8.95

Large 14 quarts

\$14.95

D₂
healthcare

TRAY COVER COUVRE PLATEAU

261
8 1/2" x 12 1/4"



261
8 1/2" x 12 1/4"

1000/case - caisse
Code: 06-350

\$27.00

OPTRAGATE®

590850WW
ExtraSoft
Lip and Cheek Retractors
Refill

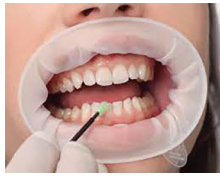

590850WW
Écarteurs
de joue/lèvre
Extra souple
Recharge

80/pack - paquet
Code: 06-349

\$144.89



**HEADREST COVERS
COUVRE D'APPUIE-TÊTE**

2-Ply Tissue + Poly
White / Blue / Lavender
Green / Pink



2-Plis Tissus + Poly
Blanc / Bleu / Lavande
Vert / Rose

10" x 10"
500/case - caisse
Code: 06-353

\$39.50

10" x 13"
500/case - caisse
Code: 06-351 OU 06-352

\$41.01

**EQUIPMENT PROTECTORS
PROTECTEURS D'EQUIPEMENT**



UBC-8031	T-Handle Cover (T-Shape) 4" x 5-3/4" 500pcs/bx	Code: 06-405	\$20.22
UBC-8033	Universal X-Ray Cover 15" x 26" 250pcs/bx	Code: 06-419	\$31.46
UBC-8021	Full Chair Cover 29" x 80" (125 pcs/box)	Code: 06-404	\$41.40
UBC-8023	Half Chair Cover 27-1/2" x 24" (225 pcs/box	Code: 06-403	\$38.20
UBC-8024	Headrest Cover 11" x 9-1/2" x 2" (250 pcs/box)	Code: 06-401	\$14.04
UBC-8025	Headrest Cover 14" x 9-1/2" x 2" (250 pcs/box)	Code: 06-402	\$19.66

**CURING LIGHT SLEEVES
COUVRE LAMPE À POLYMERISÉ**

06-409 Tip Cover Couvre embout
9 - 11mm (4 33" X 2 95") 200/PK

\$10.44

06-340 Dentmate Curing Light Sleeves
Couvre lampe à polymerisé DentMate'

\$16.50

06-410 Dentmate Light Guide Sleeves Small
Couvre embout de lampe à polymerisé petit
8mm 100/PK

\$8.43



**BARRIER FILM
FILM BARRIÈRE**

4" X 6"
Clear / Blue



4" X 6"
Clair / Bleu

1200/pack - paquet
Code: 06-407

\$17.95

**FITTED SENSOR SLEEVES
COUVRE CAPTEUR CONVENABLE**



**AIR/WATER SYRINGE SLEEVE
COUVRE SERINGURE AIR/EAU**

Size 1: 1.125"(W) x
9.25"(L)
x 1.25" (Head Size)



1: 1.125"(W) x
9.25"(L)
x 1.25" (tête)

Size 2: Fits: Kodak
6100, Schick,
Gendex GX-S, EVA
and Planmeca

2: Kodak 6100,
Schick, Gendex GX-S,
EVA et Planmeca

500/pack - paquet
Code: 06-416

\$14.95

BF-3000 -
With opening
2½" x 10"



BF-3000 -
Avec trous
2½" x 10"

500/pack - paquet
Code: 006-411

\$12.75

TRAY SLEEVES
HOUSSE POUR PLATEAUX
 500 / box / Boîte
 CODE: 06-413 (BF-7000) - 10½" x 14"



TONGUE DEPRESSOR
ABAISSE-LANGUE

CODE: 06-413 (BF-7500) - 115/8" x 16"
\$23.44
\$29.78



100% wood
 non-sterile
 6"



100% bois
 non-stérile
 6"

HANDPIECE SLEEVES
HOUSSE POUR PIÈCE À MAIN
 500/ box - Boîte
 Code: 06-412 (IN-7006) - 1½" x 8"



\$14.00

500/box -boîte

\$ 10.06

KEYBOARD SLEEVES
COUVRE CLAVIER



BITE BLOCK COVER

22" X 14"



1850
 Pano 1" x 2"

1000/box - boîte

1850S
 Siemens 1 ½" x 3"

500/box - boîte



250/Box - Boîte

\$ 27.95

Code: 06-420
 1850 / 1850S

\$ 29.95

"T" LIGHT SLEEVES
COUVRE POIGNÉE "T"



FACE SHIELD
COUVRE VISIÈRE

4" x 5.75"
 Clear plastic



4" x 5.75"
 Plastique clair

33cm X 22cm
 Full face



33cm X 22cm
 pleine lobgeur

500/Box - Boîte

\$ 19.95

Each - Chaque

\$ 7.95

PC MOUSE SLEEVES
COUVRE SOURIR PC

6.25"x 3.5"
 For PC mouse cordless
 or with cord



6.25"x 3.5"
 Pour souris
 d'ordinateur avec ou
 sans fils

HL-6601
 500/Box - Boîte

\$ 12.95



iPAD SLEEVES
COUVRE iPAD

11.6"x 8.2"
 clear plastic
 No interference with
 touch



11.6"x 8.2"
 Plastique clair
 Aucune interférence
 avec la touche

HL-6591
 100/Box - Boîte

\$29.95

STERILIZATION WRAP
EMBALLAGES DE STÉRILISATION



AUTOCLAVE TAPE
TAPE D'AUTOCLAVE



06-501	12" X 12" 1000/BOX - BOÎTE	\$128.00
06-502	15" X 15" 1000/BOX - BOÎTE	\$139.89
06-503	20" X 20" 500/BOX - BOÎTE	\$147.50
06-504	24" X 24" 500/BOX - BOÎTE	\$200.00
06-505	30" X 30" 250/BOX - BOÎTE	\$164.04
06-506	20" X 20" 100/PACK - PQT.	\$ 30.00

60 yards per roll

60 vièrges par rouleau



Code: 06-507 (AT-2001) ½" inch / pouce

\$5.95

Code: 06-508 (AT-2002) ¾" inch / pouce

\$7.95

Code: 06-509 (AT-2003) 1" inch / pouce

\$8.95

STERILIZATION POUCHES
SACS À STÉRILISATION



06-510	2 1/4" X 2 3/4"	\$ 7.81
06-511	2 1/4" X 4"	\$ 5.50
06-512	3 1/2" X 5 1/4"	\$ 9.00
06-513	2 3/4" X 10"	\$ 9.00
06-514	3 1/2" X 10"	\$ 9.95
06-515	5 1/4" X 10 or 5"X11	\$ 16.00
06-516	7 1/2" X 13"	\$ 29.95
06-517	13" X 20"	\$ 90.29
06-518	9" X 15"	\$ 42.00
06-519	5 1/2" X 7 1/4"	\$ 9.95



CHAMBER BRITE™

Autoclave cleaner



Nettoyant pour autoclave

10/Box - Boîte.
Code: 06-520

\$ 79.00

DEMENERALIZED WATER
EAU DÉMINÉRALISÉ



CHEMICAL AUTOCLAVE SOLUTION
SOLUTION POUR AUTOCLAVE CHIMIQUE

Equivalent to distilled water

Équivalente à l'eau distillé

BM7100

BM7100



4L.
Code: 06-521

\$ 6.95

Bacteriocidal solution

Solution bactéricide.

BM7000

BM7000



4L.
Code: 06-522

\$ 35.95

COMPLY™ STERIGAGE™



Class 5 integrators

Intégrateur Classe 5



500/Box - Boîte

\$129.95



SURE CHECK STRIPS
BANDES SURE CHECK

Class 4 indicators
Code: SCK

Indicateur Classe 4
Code: SCK



100/Box - Boîte

\$ 19.95

**STANDARD SALIVA EJECTORS
POMPE À SALIVE STANDARD**



**Vented Oral Evacuation Tips
EMBOUTS D'EVACUATION VENTILÉS**

SE-7000 - White w/white tip
SE-7001 - Clear w/blue tip



SE-7000 - Blanc avec embout blanc
SE-7001 - Clair avec embout Bleu

100/bag - sac
Code: 06-603

\$ 4.95

Fits all standard evacuator valves.
Non sterile.



Compatible avec tous les valves d'evacuation.
Non stérile.

100/bag - sac
Code: 06-605

\$ 5.50

**SOFT TOUCH ORAL EVACUATOR TIPS
EMBOUTS D'EVACUATION SOFT TOUCH**

Cushioned
Gentle on soft tissue and bone
Reduces soft tissue aspiration
Reduces noise



50/bag - sac
Code: 06-604

\$ 6.69

**SURGICAL ASPIRATOR TIPS
EMBOUTS D'ASPIRATION CHIRURGICAUX**

#ST-1020 - Blue 1/16"
#ST-1021 - White 1/8"
#ST-1023 - Green 1/4"

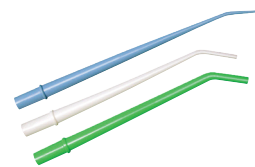

#ST-1020 - Bleu 1/16"
#ST-1021 - Blanc 1/8"
#ST-1023 - Vert 1/4"

25/bag - sac
Code: 06-607

\$ 7.95

**TRAP-EZ
TRAP-EZ**

#DT-5501 diameter 2 1/8".
#DT-5502 diameter 2 15/16".
#DT-5503 diameter 1 7/8".



#DT-5501 diametre 2 1/8".
#DT-5502 diametre 2 15/16".
#DT-5503 diametre 1 7/8".

144/box - boîte
Code: 06-608

\$ 43.00

**TRAP-EZ
TRAP-EZ**

#DT-6200C* cuspidors with small diameter openings.
#DT-HVE* all standard high volume evacuator tips.
#DT-5508S* Fits all Saliva Ejectors.
#DT-5509 diameter 1 1/2"
#DT-6100C* Fits most cuspidor bowls



#DT-6200C* couchoir avec petit trous
#DT-HVE* Standard EVE
#DT-5508S* Toutes pompes à salive.
#DT-5509 diameter 1 1/2"
#DT-6100C* couchoir standard

144/box - boîte
Code: 06-609

\$ 43.00

**TIP-A-DILLY TIPS
EMBOUTS TIP-A-DILLY**

Pelton & Crane Straw aspirator tips.



Pelton & Crane Embouts de recharge d'aspirateur paille.

200/box - boîte
Code: 06-606

\$ 12.00

Tip-A-Dilly adaptor
Each - Chaque

\$ 54.95



Gray
Sold by unit

**SALIVA EJECTOR ADAPTER
ADAPTATEUR POMPE À SALIVE**



Gray
Vender par unité

Each - Chaque
Code: 06-610

\$ 5.75

DISINFECTANTS

DÉSINFECTANTS

BM DISINFECTANTS DÉSINFECTANTS BM



06-701	BM 1000 ANTIBACTERIAL HAND SOAP 4 L.	\$24.50
06-702	BM 1200 ANTIBACTERIAL BARRIER CREAM 500ml	\$12.50
06-703	BM 1400 ANTIBACTERIAL HAND GEL 4 LITRE	\$37.00
06-704	BM 1300 ANTIBACTERIAL HAND GEL 230ml	\$ 6.00
06-705	BM 28+ ACTIVATED 2% GLUTARALDEHYDE 4L.	\$33.50
06-706	BM 4000 ISOPROPYL ALCOHOL 70% 4 L	\$39.00

06-707	BM 4100 ISOPROPYL ALCOHOL 99% 4 L.	\$44.00
06-708	BM 4200 99% DENATURES ETANOL ALCOOL 4 L.	\$34.00
06-709	BM 5000 ULTRASONIC CLEANER 4 L.	\$27.50
06-710	BM 5100 TARTAR, STAIN REMOVER 4L	\$33.00
06-711	BM 5200 PLASTER AND STONE REMOVER 4L	\$33.00
06-714	BM 6100 FOG FREE SOLUTION 1 LITRE	\$10.20
06-715	BM 6000 EVACUATION SYSTEM CLEANER 4L.	\$33.50
06-716	BM 6400 ETANOL DESINFECTATION 4 L.	\$38.00
06-717	BM 9000 WATERLINES CLEANER 1 L.	\$10.50

CAVICIDE / CAVIWIPES METRICIDE / EMPOWER



06-718	METRICIDE 1G.	\$38.00
06-719	CAVICIDE 1G	\$36.00
06-720	CAVICIDE 2.5G	\$79.95
06-721	CAVICIDE SPRAY 709 ML	\$13.50
06-722	CAVIWIPES LARGE	\$14.95
06-723	CAVIWIPES XLARGE	\$19.95
06-712	EMPOWER 1G.	\$43.95



SANI CLOTH®

Surface disinfectant wipes
Alcohol base
Large: 6" x 6.75"
160/can
X-Large: 7.5" x 15"
65/can



Lingettes Désinfectants de surfaces
À base d'alcool
Large: 6" x 6.75"
160/cannette
X-Large: 7.5" x 15"
65/cannette

Large
Code: 06-725

\$ 12.95

X-Large
Code: 06-724

\$ 14.95

PURITY WATERLINE CLEANER NETTOYANT DE LIGNE D'EAU



Compatible with all dental unit water systems.
Orderless, tasteless, non-irritating and has no effect on bonding



Compatible avec toutes systèmes de ligne d'eau.
Sans odeur, sans saveur, non-irritants, aucune effet sur l'adhesif

60 tablets / Box - Boîte
Code: 06-728

\$ 37.95

DEFEND ULTRASONIC ENZYMATIC TABLETS COMPRIMÉS ENZYMATIQUES

UT-1000
Safe for amalgam separators
Biodegradable, neutral pH
Makes 32 gallons
Non-chlorine
Non-corrosive



UT-1000
Séure sur les séparateurs d'amalgame
Biodégradable, neutral pH
Fait 32 gallons
Non-chloré
Non-aggrésif

64 tablets / Box - Boîte
Code: 06-729

\$ 73.86

ULTRASONIC ENZYMATIC TABLET COMPRIMÉS ENZYMATIQUES



Bio-Enzymatic
non foaming
non-chlorinated
anti rust



Bio-enzymatique
non moussant
non chloré
antirouille

64 tablets / Box - Boîte
Code: 06-728

\$ 39.95

SciCan OPTIM® 33TB

Your Infection Control Specialist™

Surface disinfectant
Hydrogen peroxide base



Disinfectant de surface
à base de peroxide
d'hydrogene

4L.
Code: 06-726

\$ 59.00

Canister 160/can-canette
Code: 06-727

\$ 22.00

MANUAL ENDO FILES
LIMES ENDO MANUALS



07-101	K-FILES	6/PK	\$6.50
07-102	BROACHES	6/PK	\$6.95
07-103	T-FLEX FILES	6/PK	\$6.95
07-104	H-FILES	6/PK	\$7.95
07-105	REAMERS	6/PK	\$7.95
07-116	FINGER PLUGGER	6/PK	\$9.00
07-117	FINGER SPREADERS	6/PK	\$5.81
07-118	LENTULO	4/PK	\$7.50



MANUAL ENDO FILES
LIMES ENDO MANUALS



07-106	SYBRONENDO K-FILES	6/PK	\$11.50
07-107	SYBRONENDO HEDSTROM FILES	6/PK	\$12.50
07-108	SYBRONENDO K-FLEX FILES	6/PK	\$11.95

K3™ / K3XF™ FILES
Limes K3™ / K3XF™

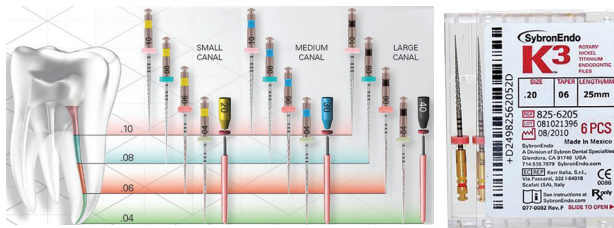

6/Pack - Paquet
Code: 07-110
\$ 79.95



TF ADAPTIVE FILES
LIMES TF ADAPTIVE

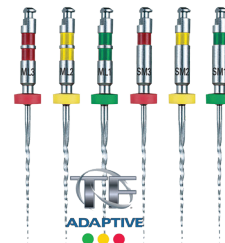

6/Pack - Paquet
Code: 07-111
\$ 79.95

TF ADAPTIVE
PAPER POINTS / GUTTA PERCHA
POINTES EN PAPIER / GUTTA PERCHA

SMALL (SM)	SM1: #20/ .04	SM2: #25/ .06	SM3: #35/ .04
MEDIUM/ LARGE (ML)	ML1: #25/ .08	ML2: #35/ .06	ML3: #50/ .04

Paper points 100/box - boîte
Code: 07-204

Gutta Percha 50/ box - boîte
Code: 07-212

\$ 21.50

SOFT CORE OBTURATORS
OBTURATEURS SOFT CORE



6/Pack - Paquet
Code: 07-209

\$ 79.95

PROTAPER / PROFILE FILES
LIMES PROTAPER ET PROFILE



ProTaper
6/pack-pqt.
Code: 07-113

\$ 59.00



ProFile
6/pack-pqt.
Code: 07-112

\$ 46.00

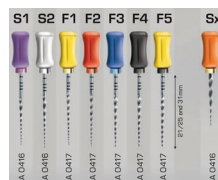

ProTaper manual
6/pack-pqt.
Code: 07-114

\$ 59.00



C-FILE / BARBED BROACHES
LIMES-C / TIRE-NERFS



C-FILE
6/pack-pqt.
Code: 07-109

\$ 18.95



Broaches / Tire-Nerfs
6/pack-pqt.
Code: 07-115

\$ 14.95

ABSORBENT PAPER POINTS
POINTES DE PAPIER ABSORBANTES

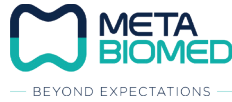

GUTTA PERCHA POINTS
POINTES DE GUTTA PERCHA



**PROTAPER
(F1-F5)**
Code: 07-203

**STANDARD
.02 Taper**
Code: 07-201

**TAPER
.04 / .06 / .08**
Code: 07-202

**PROTAPER
(F1-F5)**
Code: 07-207

**STANDARD
.02 Taper**
Code: 07-205

**TAPER
.04 / .06 / .08**
Code: 07-206

\$12.95

\$ 7.95

\$12.95

\$15.95

\$ 9.95

\$14.95

MD-CLEANSER™

EDTA 17%
100ml. bottle
1 ml. syringe



EDTA 17%
Bouteille 100ml.
Seringue 1 ml.

Code: 07-303

\$ 18.95

MD-ChelCream

EDTA 19%
2 x 5.4ml. syringes



EDTA 19%
2 x 5.4ml. seringues

Code: 07-305

\$ 29.78

ADSEAL

Resin based endodontic sealant.
Permanent root canal sealant.
Thermal obturation



Scellant en résin
Scellant de racine permanent.
Utilisé avec l'obturation thermique

13.5gm. automix
Code: 07-404

\$ 47.19

METAPEX

Calcium hydroxide with iodoform



Pâte d'hydroxyde de calcium avec iodoforme

2 x 2.2gm syringes - seringues
Code: 07-403

\$ 39.00

PULP CANAL SEALER™

Zinc oxide eugenol sealer
24875 Pulp Canal Sealer
24746 Pulp Canal Sealer
EWT



Pâte d'obturation à base d'oxyde de zinc et d'eugénol
24875 Pulp Canal Sealer
24746 Pulp Canal Sealer
EWT

10.5gm P & 4ml Liq
Code: 07-407

\$139.95



SEALAPEX™

Non-eugenol, calcium hydroxide polymeric root canal sealer.



Pâte sans eugénol formulée à base d'hydroxyde de calcium polymérique.

12gm base + 12gm. cat.
Code: 07-406

\$ 64.00

TM

ENDODONTICS

ENDODONTIES

TUBLI-SEAL™

Root canal paste with a base of zinc oxide eugemol



Scellant canalaire à base d'oxide de zinc et eugéno



10gm base + 3.5gm. cat.
Code: 07-405

\$ 59.00

PULPDENT® MULTI-CAL™

Dental Innovation Since 1947

Non-setting calcium hydroxide paste



Pâte d'hydroxyde de calcium non durcissante

4 x 1.2ml. syringes - seringues
Code: 07-401

\$ 74.00

AH PLUS®

Resin based root canal sealant



Pâte de scellement à base de résin



Paste A & B 4ml. each - chaque
Code: 07-408

\$129.10

GLYDE™

Root canal lubricant



Conditionneur pour canaux radiculaires

5 x 3 ml syringes - seringues
Code: 07-302

\$ 43.82

ENDO-ICE®

Vitality Refrigerant Spray



Réfrigérant pour diagnostic pulpaire

5.7oz. can - cannette
Code: 07-301

\$ 28.03



Chemo-Mechanical Preparation of Root Canals

RC-PREP®



Préparation chimio-mécanique pour canaux radiculaires

18gm. jar - pot
Code: 07-306

\$ 47.19

CHLOR XTRA

6% Sodium hypochlorite



Hypochlorite de sodium 6%

16oz. bottle - bouteille
Code: 07-307

\$ 89.95



SmearClear®

EDTA 17%



17 % d'EDTA

10ml. bottle - bouteille
Code: 07-304

\$ 55.06

ISODAM®

NON-LATEX

5" x 5" (20/pk)	Blue	Bleu	Medium	Moyen
5" x 5" (20/pk)	Blue	Bleu	Heavy	Épais
6" x 6" (15/pk)	Blue	Bleu	Medium	Moyen
6" x 6" (15/pk)	Blue	Bleu	Heavy	Épais



Code: 07-501

\$ 32.00

BIODAM®

LATEX

5" x 5" (52/pk)	Mince	Thin
5" x 5" (52/pk)	Moyen	Medium
5" x 5" (52/pk)	Épais	Heavy
6" x 6" (36/pk)	Mince	Thin
6" x 6" (36/pk)	Moyen	Medium
6" x 6" (36/pk)	Épais	Heavy



Blue / Green - Blue / Vert
Code: 07-501

\$ 11.95

HYGENIC RUBBER DAM
DIGUE DENTAIRE HYGENIC



HYGENIC NON-LATEX RUBBER DAM
DIGUE DENTAIRE HYGENIC
SANS-LATEX

Latex rubber dam
5" x 5" : 52/pack
6" x 6" : 36/pack



Digue dentaire en latex
5" x 5" : 52/paquet
6" x 6" : 36/paquet

Blue / Green - Blue / Vert
Code: 07-502

\$ 24.16

5" x 5" : 20/pack
6" x 6" : 15/pack



Digue dentaire en latex
5" x 5" : 20/paquet
6" x 6" : 15/paquet

Blue / Green - Blue / Vert
Code: 07-503

\$ 56.00

HYGENIC® FLEXI DAM®

High resistance
High flexibiity
Non-Latex



Résistance et flexibilité
élevées
Sans latex

30/box - Boîte
Code: 07-504

\$ 61.24

HYGENIC® FRAMED FLEXI DAM®
FLEXI DAM HYGENIC® AVEC CADRE

Dam with integrated
frame
Non-Latex



Digue avec cadre intégré
Sans latex

20/box - Boîte
Code: 07-504

\$ 84.00

HYGENIC® ORA-SHIELD®

Dental digue napkins



Serviettes pour digue
dentaire

50/box - Boîte
Code: 07-511

\$ 34.74



ENDO AID KIT & REFILLS
ENSEMBLE ENDO AID

Autoclavable

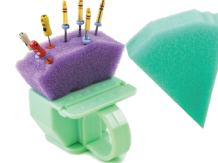

Autoclavable

ENDO RING
Each - chaque
Code: 07-509

\$ 49.00

ENDO FOAM
50/pack - paquet
Code: 07-510

\$ 39.50

**SOFLEX™ DISCS
DISQUES SOFLEX**

Regular - Régulier

1981 (C/M/F/SF) : 3/8"
1982 (C/M/F/SF) : 1/2"

Ultra Thin - Ultra Mince

2381 (C/M/F/SF) : 3/8"
2382 (C/M/F/SF) : 1/2"

85/pack - paquet

Code: 08-103

Abrasive Grades	Sof-Lex			Sof-Lex Extra Thin (XT)	
Superfine	1958SF	1982SF	1981SF	2382SF	2381SF
Fine	1958F	1982F	1981F	2382F	2381F
Medium	1958M	1982M	1981M	2382SM	2381M
Coarse	1958C	1982C	1981C	2382C	2381C

\$ 74.95



**SOFLEX™ FINISHING STRIPS
BANDES DE FINITION SOFLEX**

Coarse / Medium
150/Box
1954 : regular
1954N: narrow
Code: 08-101



Grain gros/moyen
1954 : réguliers
1954N: étroites
Code: 08-101

Fine / Extra-Fine
100/Box
1956
Code: 08-102

Fin / Extra-Fin
100/boîte
1956
Code: 08-102

\$ 54.95

**POP-ON MANDRELS
MANDRINS POP-ON**

Soflex discs mandrel
Contra-angle



Mandrins pour le
disques Soflex
Contra-angle

3/packs - paquets
Code: 08-104

\$ 29.00



**ENHANCE® Finishing system
Système de finition**

624045X Discs
624055X Cups
624065X Points



624045X Disques
624055X Cupules
624065X Pointes

30/packs - paquets
Code: 08-105

\$ 84.95

BROWNIE®/GREENIE®/SUPERGREENIE®

Silicone polishers used on precious metals and amalgam.
Des polissoirs de silicone utilisés sur les métaux précieux et l'amalgame.



ISO No.	Shape	Cup 065	Mini-Point 030	KN7 125	PC2 050	WH6 120	Floppie 220	Disk 180	unmounted Wheel 220
Brownie (propolish)	HP 12 pcs			0271	0272	0273	0458	0405	0453
	CA 12 pcs	0401	0403	0281	0282	0283			
	FG 12 pcs	H401	H403						
	FG 72 pcs	0411	0413						
Greenie (polish)	HP 12 pcs			0274	0275	0276	0459		0454
	CA 12 pcs	0402	0404	0284	0285	0286		0406	
	CA 72 pcs	H402	H404						
	FG 12 pcs	0412	0414						
Supergreenie (superpolish)	HP 12 pcs			0277	0278	0279			454A
	CA 12 pcs	402A	404B	0287	0288	0289			
	FG 12 pcs	412A	414B						

08-107	BROWNIE CUPS	12/ PK CA 0400	\$ 37.95
08-108	BROWNIE MINI POINTS	FG 0413 12/BOX	\$ 37.95
08-109	BROWNIE MINI POINTS	CA 0403	\$ 37.95
08-110	BROWNIE MINI POINTS	72/PK	\$188.33
08-111	SHOFU BROWNIE	HP 12/ PK CA 0271	\$ 39.95
08-116	GREENIE MINI POINTS	CA 0404 12/BOX	\$ 37.95
08-114	DURA WHITE	12/BOX FG, CA AND HP	\$ 37.95

SUPER-SNAP® SUPERBUFF™



08-119	BUFF DISK PN L523	25/BOX	\$ 34.95
08-120	BUFF DISK	50/BOX	\$ 34.95
08-121	BUFF MINI DISK L524	25/PK	\$ 34.95
08-122	DISK L509	50/BOX	\$ 34.95
08-123	POLYSTRIPS BLACK/VIOLET COARSE/MEDIUM	100/PK	\$ 37.31
08-124	RAINBOW TECHNIQUE KIT		\$143.87

ONEGLOSS®

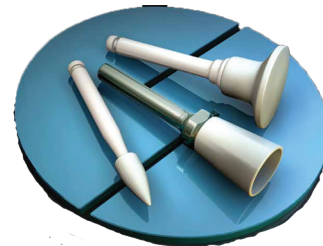

08-106	ONE GLOSS REFILL	50/BOX	\$133.65
08-117	MINI POINTS REFILL	12/PK	\$ 37.70
08-118	ONE GLOSS SET	20 CUP, 20 POINT, 20 DISK, 3 MANDREL /BOX	\$159.95

CompoSite 2-step polishing
Polissage 2-étapes



SHAPE CATEGORY	Bullet	Knife	Wheel	Disk	Cup	Pear-Point	IC	Mid-Point
SHAPE								
ISO #	040	090	090	160	080	033	-	040
REGULAR (one hand)								
CA (12 pk)	PN	0191	0192	0193	0194	0195	0196	0197
FG (12 pk)	PN	-	-	-	-	-	196B	0199
FINE (two hand)								
CA (12 pk)	PN	0291	0292	0293	0294	0295	0296	0297
FG (12 pk)	PN	-	-	-	-	-	296B	0299

08-112	Fine Polisher, Bullet, CA, 0291, 12/BOX	\$43.39
08-113	Polish, Bullet, CA, 0191, 12/box	\$42.14

JOTA SWISS: PREMOUNTED DIAMOND DISCS
DISCS DIAMANTES PRE-MONTÉES

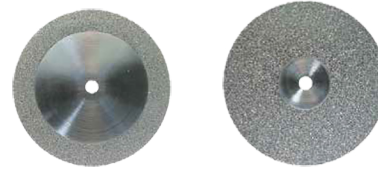

SUPERFLEX
Double sided
double côtés

08-129	915D.HP.219	\$21.29
08-130	921DF.HP.219	\$21.29

TDIA TURBO DIAMOND COMPOSITE POLISHERS
POLISSOIRS DIAMANTÉS POUR COMPOSITE



Medium OR Fine
14 x 1.9 mm



Moyen OU Fine
14 x 1.9 mm

3/Pack - Paquet
Code: 08-125

\$ 52.26

NAIS MICROFILL 2 STEPS POLISHERS
POLISSAGE DEUX-ÉTAPES

Yellow: Fine:
Satin finish

Light Blue: Ultra-Fine
High gloss

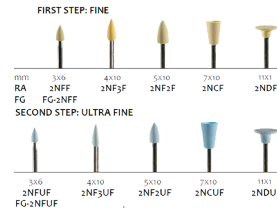

Jaune: Fine:
Finition satinée

Bleu pal: Ultra-Fine
Haute brillance

12/Pack - Paquet
Code: 08-126

\$ 29.00

ONE-STEP COMPOSITE POLISHERS
UNE-ÉTAPE POLISSOIRS DE COMPOSITE

RA
Speed:
3,000 - 10,000
rpm

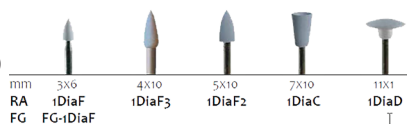

RA
Vitesse:
3,000 - 10,000
rpm

6/Pack - Paquet
Code: 08-128

\$ 32.28

2 STEPS DIA DIAMOND POLISHERS
DIA DEUX-ÉTAPES POLISSOIRS DIAMANTÉS

Light Blue (Medium)
Finishing

Yellow (Fine)
High shine

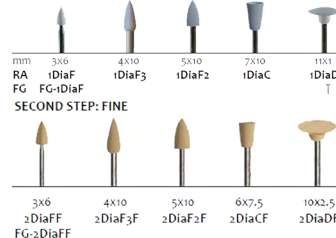

Blue pal (Moyen):
Finition

Jaune (Fin)
Haute brillance

6/Pack - Paquet
Code:

\$ 23.70

Gc METAL STRIPS
BANDES EN MÉTAL



Size A: 2.6mm.
Size B: 3.3mm.
Size C: 4.0mm

Red : Coarse
Blue : Medium
Green: Fine
Yellow: Ultra-Fine



Largeur A: 2.6mm.
Largeur B: 3.3mm.
Largeur C: 4.0mm

Rouge : Rugueux
Bleu : Moyen
Vert : Fin
Jaune : Ultra-Fine

12/Pack - Paquet
Code: 08-131

\$139.95



LIGHTNING STRIPS
BANDES LIGHTNING



	Narrow	Medium	Wide	Assorted
	2.38 mm	3.17 mm	3.97 mm	
Fine	620-81010	620-81030	620-81050	620-81210
Medium	620-81070	620-81090	620-81110	620-81230
Coarse	620-81130	620-81150	620-81170	620-81250
Assorted	620-81290	620-81270	620-81310	620-81190

10/Pack - Paquet
Code: 08-132

\$ 24.16

DENSCO®
PROFLEX FLEXIBLE SCALER
DÉTARTEREUR FLEXIBLE PROFLEX



085000-000 :
 Efficient scaling and stain
 removal



085000-000:
 Détartrage et enlèvement
 de tâche

3 feet roll / pieds rouleau
 Code: 08-133

\$ 35.96



PRISMA GLOSS
COMPOSITE POLISHING PASTE
PÂTE DE POLISSAGE POUR COMPOSITES

Fine-grit aluminum
 oxide powder
 suspended in a
 glycerine base.
 Fine : 631400
 Extra-Fine: 631450



Fine poudre d'oxyde
 d'aluminium dans
 une suspension de
 glycérine.
 Fin : 631400
 Extra-Fin: 631450

4gm. syringe - seringue
 Code: 08-134

\$ 79.95

SOFLEX DIAMOND POLISHERS
POLISSOIRS DIAMANTÉS SOFLEX



EPITEX®

5090:
 Pre-polishers

 5091:
 Fine polishers



5090:
 Prépolissage

 5091:
 Polissoirs fins

15/pack - paquet

5090

\$ 53.95

5091

\$ 73.95

Finishing & polishing
 strips.
 Coarse / Medium
 Fine / Extra-Fine



Bandes de finition et
 polissage
 Rugueuse / Moyen
 Fin / Extra-Fin

10m/roll- rouleau

\$ 66.54

ASTROPOL® P & F



Politip^{MC} P & F

Grey : Finisher
 Green: Polishers

Small flame
 Large flame
 Cup
 Disk



Gris : Finition
 Vert: Polissage

Flame Petit
 Flame Large
 Cupule
 Disque

6/pack - paquet

\$ 38.95

Grey : Finisher
 Green: Polishers

Shape B (Flame)
 Shape C (Large Cup)
 Shape D (Small Cup)



Gris : Finition
 Vert: Polissage

Forme B (Flame)
 Forme C (Large Cupule)
 Forme D (Petite cupule)

6/pack - paquet

\$ 38.95

POGO®



Sparkle™ Diamond Polishing Paste
Pâte à polir diamantée

Diamond polishing
 system

Discs
 Cups
 Points



Système de polissage
 diamanté

Disques
 Cupules
 Points

40pack - paquet

\$214.95

Produces a glaze-like
 high luster finish on
 porcelain, gold, com-
 posite and metal



Produit un fini bril-
 lant avec effet lustré
 sur la porcelaine, le
 composite l'or et le
 métal.

3ml. syringe / seringue

\$ 27.95

EQUIPMENT

EQUIPEMENT

LEDEX™ WL-070

Light cure unit
Lampe à polymériser



5W LED. It can cure the composites over 3mm in 10 secs.



5W DEL. capable à polymériser 3mm. de composite dans 10 seconds.

Light guide 8mm (09-104) : **\$53.55**
Light guide protector (09-103) : **\$ 2.25**
Anti-Glare plastic shield (09-102) : **\$ 4.50**

Code: 09-101
\$223.60

SABLE EZ LUBE SPRAY

INDUSTRIES INC.
ISO 13485 2015 CERTIFIED • HEALTH CANADA REGISTERED

2200103 :
One step lubricant for handpieces



2200103 :
Un étape lubrifiant pour les pièces à main

500ml. can - cannette
Code: 09-303

\$ 66.29

KAVO SPRAY®

Universal handpiece lubricant



Lubrifiant de pièce à main universel

500ml. can - cannette
Code: 09-301

\$ 48.00

Kavo spray nozzle regular / Multiflex
Code: 09-302

\$ 12.00



Kavo. Dental Excellence.

QUATTROCARE® PLUS

Handpiece lubricant for use in QuattroCare Plus machine



Lubrifiant de pièce à main pour utiliser dans la machine QuattroCare Plus

500ml. can - cannette
Code: 09-301

\$ 59.95

AIR SCALER AS2000

Weight (Midwest 4 Hole) 67 g
Frequency of Oscillation 5,600-5,850 Hz
Contents
3 Tips (S1, S2, S3) Tip
Wrench (CR-20) Tip
Cover (L)



Poid: (Midwest 4 Trous) 67 g
Vitesse d'Oscillation 5,600-5,850 Hz
Contenants
3 embouts (S1, S2, S3)
Clé d'embouts (CR-20)
Couvre embout (L)

Code: 09-327

\$364.62

Tip - Embouts
Code: 09-328

\$ 45.28



PANA MAX PLUS handpiece Pièce à main

Non-Optic
Model: PAP-QD SU P1016
Standard Head
Speed : 340,000~410,000 min
Head Size : ø12.1 x H13.3 mm



Non-Optique
Model: PAP-QD SU P1016
Tête standard
Vitesse : 340,000~410,000 min
Grandeur de tête : ø12.1 x H13.3 mm

Code: 09-304

\$322.02

DYNA LED MODEL M600LG handpiece Pièce à main

Optic
Model: M600L P1002
Standard Head
Power : 20 W,
Speed : 360,000~430,000 min
Head Size : ø12.1 x H13.3 mm



Optique
Model: M600L P1002
Tête standard
Pouvoir : 20 W,
Vitesse : 360,000~430,000 min
Grandeur de tête : ø12.1 x H13.3 mm

Code: 09-305

\$654.49

PANA MAX handpiece pièce à main

Non optic
Model: Pana Max T114002
Standard Head
Speed : 380,000~480,000 min
Head Size : ø10.3 x H13.5 mm



Non optique
Model: Pana Max T114002
Tête standard
Vitesse : 380,000~480,000 min
Grandeur de tête : ø10.3 x H13.5 mm

Code: 09-306

\$247.25



EX Series Heads & Handpieces

External Water Spray

Heads for General Application
Non-Optic

- MODEL **FPB-Y** ORDER CODE **C875**
 - For CA burs (ø2.35) • Clean Head System
 - Push Button Chuck • Ball Bearing
 - Max Speed: 40,000 min⁻¹
- MODEL **NAC-Y** ORDER CODE **C032002**
 - For CA burs (ø2.35) • Latch type
 - Max Speed: 30,000 min⁻¹
- MODEL **BB-Y** ORDER CODE **C037**
 - For CA burs (ø2.35) • Latch type
 - Ball Bearing • Max Speed: 40,000 min⁻¹
- MODEL **NBBW-Y** ORDER CODE **C211**
 - For CA burs (ø2.35) • Latch type • Ball Bearing
 - With Water Nozzle • Max Speed: 40,000 min⁻¹
- MODEL **NM-Y** ORDER CODE **C247**
 - Miniature Head • Latch type
 - For CA burs (ø2.35) • Max Speed: 30,000 min⁻¹
- MODEL **FFB-Y** ORDER CODE **C884**
 - For FG burs (ø1.6) • Clean Head System
 - Push Button Chuck • Max Speed: 40,000 min⁻¹
- MODEL **NRS2-Y** ORDER CODE **C549**
 - 10:1 Reduction • For CA burs (ø2.35)
 - Clean Head System • Push Button Chuck
 - Max Speed: 3,000 min⁻¹

Heads for Prophylaxis Application
Non-Optic

- MODEL **AR-Y (S)** ORDER CODE **C187**
 - For screw-in cups and brushes
 - Max Speed: 5,000 min⁻¹
- MODEL **AR-Y (K)** ORDER CODE **C188**
 - For snap-on cups
 - Max Speed: 5,000 min⁻¹

1:1 Direct Drive



Non-Optic MODEL **FX25m** ORDER CODE **C1052001**
 For CA burs (ø2.35) • Push Button Chuck
 Stainless Steel Body • Clean Head System
 Ball Bearing • Max Speed: 40,000 min⁻¹

1:1 Direct Drive



Non-Optic MODEL **FX22** ORDER CODE **C1129001**
 For CA burs (ø2.35) • Latch type
 Max Speed: 30,000 min⁻¹

Handpieces

- MODEL **EC** ORDER CODE **C100008**
- MODEL **ECM** ORDER CODE **C100007**
1:1 Direct Drive
- MODEL **ER4** ORDER CODE **C634**
- MODEL **ER4M** ORDER CODE **C634002**
4:1 Reduction
- MODEL **ER10** ORDER CODE **C635**
- MODEL **ER10M** ORDER CODE **C635002**
10:1 Reduction
- MODEL **ER16** ORDER CODE **C636**
- MODEL **ER16M** ORDER CODE **C636002**
16:1 Reduction
- MODEL **ER64** ORDER CODE **C637**
- MODEL **ER64M** ORDER CODE **C637002**
64:1 Reduction

Air Motors

External Water Spray



MODEL **EX-203C M4** ORDER CODE **M195**
 1:1 Direct Drive • Midwest 4 hole
 Max speed 20,000 min⁻¹

Internal Water Spray



Non-Optic MODEL **M205** ORDER CODE **M1007**
 • Stainless Steel Body • Non-Retraction Valve
 • Midwest 4 hole • Max. 25,000 min⁻¹

Straight Handpiece

1:1 Direct Drive



Non-Optic MODEL **FX65m** ORDER CODE **H1014001**
 For HP burs (ø2.35) • Stainless Steel Body
 Clean Head System • Max Speed: 40,000 min⁻¹

09-313	CONTRE ANGLE PUSH BUTTON MODEL: FX25	\$250.56
09-314	ATTACHEMENT NOSECONE MODEL: FX65	\$182.87
09-315	CONTRE ANGLE LATCH MODEL: FX22	\$203.93
09-316	CONTRE ANGLE HEAD MODEL: NAC Y	\$ 94.38
09-317	CONTRE ANGLE SHANK MODEL: EC 30	\$106.74

09-318	PUSH BUTTON LATCH HEAD MODEL: FPB Y	\$ 143.82
09-319	PROPHY HEAD SNAP ON MODEL AR Y (K) C188	\$ 50.56
09-320	PROPHY HEAD SCREW IN MODEL AR Y (S) C187	\$ 50.56
09-324	AIR MOTOR MODEL EX 203C M4 M195	\$ 325.84
09-326	HANDPIECE AIR MOTOR MODEL: FX205 M4	\$ 325.84

TI-MAX "X" Quattro Spray

Optic
 Model: X95L - C600
 • For FG burs (ø1.6)
 1:5 Increasing
 • Ceramic Bearings
 • Max Speed:
 200,000 min



Optique
 Model: X95L - C600
 • Fraises FG (ø1.6)
 1:5
 • Ceramique
 • Vitesse maximale
 200,000 min

Code: 09-321

\$1236.52

TI-MAX "Z" Quattro Spray

Optic
 Model: Z95L - C600
 • For FG burs (ø1.6)
 1:5 Increasing
 • Ceramic Bearings
 • Max Speed:
 200,000 min



Optique
 Model: Z95L - C600
 • Fraises FG (ø1.6)
 1:5
 • Ceramique
 • Vitesse maximale
 200,000 min

Code: 09-322

\$ 926.97

NSK COUPLER LED
RACCORD DEL



Model: T334051
 Code: 09-311

\$ 223.95

KROMOPAN

Extra-Fast set
168 hrs. dimensional
stability



1lb.
Code: 10-102

\$ 11.95

ALGINATE



Prise extra-rapide
Stabilité dimensionnelle
168 hrs.

Extra-Fast set
168 hrs. dimensional
stability
Dust free
Stawberry flavor



1lb.
Code: 10-103

\$ 15.67

IQ CHROM

Fast set
Chromatic phase
Mint flavor



1lb.
Code: 10-101

\$ 10.67



Prise rapide
Phase chromatique
Savoir Menthe



9010 :
Fast Set
8 x 50ml cartridges

**ALGINATE ALTERNATIVE
ALTERNATIF D'ALGINATE**



Code: 10-110

\$ 96.13

9010 :
Prise rapide
8 x 50ml cartouches

JELTRATE® PLUS

Fast set
Dust free



1lb.
Code: 10-105

\$ 23.50

Prise rapide
Sans poussiere



JELTRATE® CHROMA

Fast set
Dust free
Chromatic phase



1lb.
Code: 10-106

\$ 23.50

Prise rapide
Sans poussiere
Phase chromatique

HYDROGUM 5

Extra-Fast set
Dust free
5 days stability



1lb.
Code: 10-108

\$ 15.67

Prise extra-rapide
Sans poussiere
Stabilité 5 jours



HYDROGUM

Fast set
Dust free
Mint flavor



1lb.
Code: 10-109

\$ 15.67

Prise rapide
Sans poussiere
Savoir menthe

IMPREGUM™ F

Polyether impression material used as polyether precision monophasic technique with manual mixing



Matériaux d'empreinte de précision polyéther pour la technique monophasique (mélange manuel)

Double pack - Paquet double
Code: 10-201

\$166.29

POLYETHER



Polyether impression material for C&B, Inlays and Onlays. Impression for implants



Empreintes Polyéther de couronnes et ponts d'inlays et onlays
Empreintes d'implants

Refill: 300ml. base 60ml catalyst
Code: 10-202

\$443.82

IMPREGUM™ PENTA™ SOFT

Less rigid polyether is easier to remove, great for dual-arch trays.



Polyéther qu'est moins rigide et facile à enlever
Magnifique pour les portes empreintes double

Refill: 300ml. base 60ml catalyst
Code: 10-203

\$443.82

POLYETHER TRAY ADHESIVE

For use with Impregum and other polyether impression materials



Pour utiliser avec Impregum et les autres matériaux de empreintes à base polyéther

17ml. bottle - bouteille
Code: 10-204

\$ 26.40

EXPRESS™

Vinyl polysiloxane automix system with excellent elastic recovery.

- 7322 Regular body regular set purple
- 7302 Light body regular set green
- 7301 Light body fast set blue



Matériaux d'empreinte vinyl polysiloxane automix avec bonne stabilité dimensionnelle
7302 Light - prise normale (vert)
7301 Light - prise rapide (bleu)
7322 Express Medium prise normale (violet)

4 x 50ml. cartridges - cartouches
Code: Light: 10-304 Regular 10-305

\$ 79.95

VPS

- 7312: 1 - 305ml Jar of Base
- 1 - 305ml Jar of Catalyst



- 7312: 1 pot base (ocre) de 305 ml,
- 1 pot de catalyseur (gris) de 305 ml

Code: 10-306

\$119.95

AQUASIL ULTRA

- 678773 Monophase - Regular Set
- 678774 Monophase - Fast Set
- 678775 Heavy - Regular Set
- 678776 Heavy - Fast Set
- 678771 LV - Regular set
- 678772 LV - Fast Set



- 678773 Monophase - Prise régulière
- 678774 Monophase - Prise rapide
- 678775 Dense - Prise régulière
- 678776 Dense - Prise rapide
- 678771 LV - Prise régulière
- 678772 LV - Prise rapide

4 x 50ml. cartridges - cartouches
Code: 10-308

\$155.06



REPROSIL

- 1 Tube Base (90mL)
- 1 Tube Catalyst (90mL)

- 626170 Light Body
- 626175 Regular Body



- 1 Tube Base (90mL)
- 1 Tube Catalyseur (90mL)

- 626170 Viscosité légère
- 626175 Viscosité moyenne

Code: 10-309

\$ 76.97

FLEXITIME® VPS



KULZER
MITSUBI CHEMICALS GROUP

FLEXITIME® DYNAMIX

2 x 50 ml Cartridges
(with Mix Tips)



2 x 50 ml Cartouches
(avec embouts)

Heavy Tray
Correct Flow

Heavy Tray
Correct Flow

Code: 10-310

\$ 53.93

2 x 380 ml

Heavy Tray
Monophase



2 x 380 ml

Heavy Tray
Monophase

Code: 10-312

\$298.00

FLEXITIME® EASY PUTTY

Easy Putty (4 x 600 ml)



Easy Putty (4 x 600 ml)

Code: 10-311

\$118.00



TRAY ADHESIVE

To be used with all
VPS impression materials



Compatible avec tous
matériaux de prise
d'empreinte

17ml. bottle - bouteille
Code: 10-315

\$ 31.50

**MARK3 VPS IMPRESSION MATERIAL
MATÉRIAU D'EMPREINTE VPS**



VPS PUTTY

3010 Light RS
3011 Light FS
3012 Medium RS
3013 Medium FS
3014 Heavy RS
3015 Heavy FS
3016 Monophase RS
3017 Monophase FS



3010 Légère RS
3011 Légère FS
3012 Moyen RS
3013 Moyen FS
3014 Heavy RS
3015 Heavy FS
3016 Monophase RS
3017 Monophase FS

4 x 50ml. cartridges - cartouches
Code: 10-301

\$ 42.50

3004 Regular Set
Work Time - 2 mins.
Set Time - 4 mins.



3004 Prise régulière
Temps de travail 2 mins.
Temps de prise - 4 mins.

3005 Fast Set
Work Time - 1 min.
Set Time - 3 mins.

3005 Fast Set
Temps de travail 1 min.
Temps de prise -3 mins.

300ml. base & catalyst each - chaque
Code: 10-303

\$ 64.61

MARK3 VPS 380

3025 Heavy RS
3026 Monophase RS
3027 Heavy FS



3025 Heavy RS
3026 Monophase RS
3027 Heavy FS

2 x 380ml. cartridges - cartouches
Code: 10-302

\$212.92

MARK3 VPS TRAY ADHESIVE

For use with any
VPS impression material



Compatible avec tous
matériaux de prise
d'empreinte

10ml. bottle - bouteille
Code: 10-317

\$ 21.35

MARK3 VPS BITE

Bite registration MARK3 MAX BITE

0218 Regular Set
0219 Fast Set
0220 Super Fast Set



4 x 50ml. cartridges - cartouches
Code: 10-402

\$ 56.00

0218 Prise régulière
0219 Prise rapide
0220 Super rapide



1170 Regular Set
1171 Fast Set
1172 Super Fast Set



2 x 50ml. cartridges - cartouches
Code: 10-401

\$ 32.00

1170 Prise régulière
1171 Prise rapide
1172 Super rapide

BLU-MOUSSE®

S457S
Exceptional precision

Comparable hardness to plaster (85 durometers)



2 x 50ml. cartridges - cartouches
Code: 10-405

\$ 64.99



S457S
Précision exceptionnelle

Dureté comparable à celle du plâtre (85 duromètres)



BR-9200
Work time 1:00 minutes
Intra oral set 1:00 minute
Durometer 60-65 (Shore A)
Clear & unflavored

CLEAR BITE



2 x 50ml. cartridges - cartouches
Code: 10-403

\$ 42.47

BR-9200
Temps de travail: 1:00 min.
Prise intra-buccal: 1:00min.
Duromètre: 60-65 (Shore A)
Clair sans saveur

PLASTOPASTE™

0921590 :
Light body zinc oxide eugenol impression paste



7.5oz. base + 3.25 oz. catalyst
Code: 10-510

\$ 64.95



SUPERPASTE™

0921850 :
Heavy body zinc oxide eugenol impression paste



7.5oz. base + 3.25 oz. catalyst
Code: 10-510

\$ 69.95

0921850 :
Pâte d'empreinte ZOE d'haute viscosité

IMPRESSION COMPOUND

00431
Red Cakes (227 g)

00447
Green Sticks (113 g)



Code: 10-509

\$ 44.95



00431
Plaques rouges 227g.

00447
Bâtons verts 113g.



015100-000
Medium body
A Hardener 2.8 oz (80 g),
B Base 2.3 oz (65 g)

KREX® ZOE IMPRESSION



Code: 10-510

\$ 49.95

015100-000
Viscosité moyenne
A Durcisseur 2.8 oz (80 g),
B Base 2.3 oz (65 g)

TRA-TENS® IMPRESSION TRAYS
PORTES EMPREINTES



Excellent mechanical retention.
Perforated
#1 SU #2 MU #3 LU
#4 SL #5 ML #6 LL
#7 ANT. #8 UL&LR
#9 UR & LL

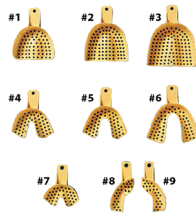

Retention mécanique excellente
Perforé
#1 SU #2 MU #3 LU
#4 SL #5 ML #6 LL
#7 ANT. #8 UL&LR
#9 UR & LL

12/pack - paquet
Code: 10-602

\$ 14.55



TRIPLE TRAY®

- 1006213: Anterior - 35/bx
- 1006203: Posterior - 48/bx
- 1006223: Quadrant - 40/bx
- 1006233: Assorted - 35/bx
- 1006243: Sideless Posterior - 48/bx
- 1006253: Extended Quadrant - 35/bx
- 1006273: 3/4 Arch - 35/bx
- 1006283: Posterior Wide Body - 48/bx



Code: 10-607

\$ 65.17

DISPOSABLE IMPRESSION TRAYS
PORTES EMPREINTES JETABLES



- 1001 #1 Upper Large
- 1002 #2 Lower Large
- 1003 #3 Upper Medium
- 1004 #4 Lower Medium
- 1005 #5 Upper Small
- 1006 #6 Lower Small
- 1007 #7 UL-LR
- 1008 #8 UR -LL
- 1009 #9 Anterior Upper
- 1010 #10 Anterior Lower



- 1001 #1 Haut Large
- 1002 #2 Bas Large
- 1003 #3 Haut Moyen
- 1004 #4 Bas Moyen
- 1005 #5 Haut Petit
- 1006 #6 Bas Petit
- 1007 #7 UL-LR
- 1008 #8 UR -LL
- 1009 #9 H. Antérieur
- 1010 #10 B. Antérieur

12/pack - paquet
Code: 10-601

\$ 6.95

BITE TRAY
GOUTIÈRES D'OCCLUSION

- 0205 Full Arch 30/bx
- 0201 Anterior 35/bx
- 0202 Quadrant 35/bx
- 0204 Sideless Posterior 50/bx
- 0203 Posterior 50/bx



Code: 10-605

\$ 29.78

STAINLESS STEEL TRAYS
PORTES EMPREINTES EN ACIER



- #1 - PERF, LOWER, XS
- #2 - PERF, LOWER, SM
- #3 - PERF, LOWER, MED
- #4 - PERF, LOWER, LG
- #5 - PERF, LOWER, XL
- #6 - PERF, UPPER, XS
- #7 - PERF, UPPER, SM
- #8 - PERF, UPPER, MED
- #9 - PERF, UPPER, LG
- #10 - PERF, UPPER, XL

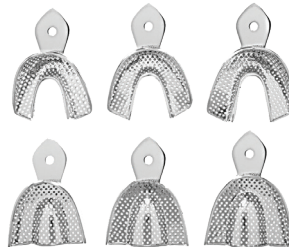

Each - Chaque
Code: 10-603

\$ 12.00



BITE TRAY
GOUTIÈRES D'OCCLUSION

- BT-1001 Anterior 35/bx
- BT-1002 Posterior 50/bx
- BT-1003 Sideless posterior 50/bx
- BT-1004 Quadrant 35/bx



Each - Chaque
Code: 10-606

\$ 29.78

BITE RELATOR™ 2000



RITE-BITE TRAY

3-in-1, dual-arch impression trays
Xi Extended™ features longer buccal sides.
Distortion-free stainless steel frame



3-en-1 est porte-empreintes à double arcade
Xi Extended™ se caractérise par des côtés buccaux plus longs.
Cadre en acier inoxydable sans distorsion

Inserts for Bite Relator autoclavable



Encarts pour Bite Relator. Autoclavable

1 Frame + 12 inserts / 1 Cadre + 12 encarts
Code: 10-608

\$ 44.38

100 / box - boîte
Code: 10-609

\$ 52.25

HP MIXING TIPS
EMBOUS MÉLANGEURS



INTRA-ORAL MIXING TIPS
EMB. MÉLANGEURS INTRA-BUCCAUX

#VP-8105 - Yellow
#VP-8106 - Pink
#VP-8104 - Teal



48/pack - paquet
Code: 10-610

\$ 38.00

#VP-8105 - Jaune
#VP-8106 - Rose
#VP-8104 - Sarcel

#VP-8002 Large clear
#VP-8101SM Small clear
#VP-8103 Yellow



100/pack - paquet
Code: 10-611

\$ 18.00

#VP-8002 Large clair
#VP-8101SM Petit clair
#VP-8103 Jaune

RIBBON TIPS
EMBOUS POUR RUBANS

Tips are used with bite registration material.



Utilisés avec du matériau pour enregistrement d'occlusion.

24/pack - paquet
Code: 10-613

\$ 11.67

DYNAMIX MIXING TIP
EMBOUS MÉLANGEURS

1419:
Compatible with all 380ml. cartridges



1419:
Compatible avec tous cartouches de 380ml.

50/pack - paquet
Code: 10-613

\$ 59.00

MIXING BOWLS
BOLS DE MÉLANGE



DISPENSING GUN
FUSIL MÉLANGEUR

1520 X Small, 160ml
1521 .Small, 320ml
1522 .Medium, 500ml
1523 .Large, 700ml



1520 X Petit, 160ml
1521 .Petit, 320ml
1522 .Moyen, 500ml
1523 .Large, 700ml

X-Small / Small Code: 10-614

\$ 5.95

Medium / Large

\$ 6.95

110411:
Type 50
1 : 1 / 2 : 1



110411:
Type 50
1 : 1 / 2 : 1

Each - chaque
Code: 10-615

\$ 80.00

ORANGE SOLVENT
SOLVANT D'ORANGE



TARTAR & STAIN REMOVER
NETTOYANT DE TARTRE ET TACHE

BM6300
For removing Zinc oxide, rubber base and other impression materials



1L.
Code: 10-613

\$ 15.50

BM6300
Pour enlever les matériaux d'empreintes à base de oxide de zinc, caoutchouc et des autres matériaux d'empreintes

BM5100
Professional remover for tartar and stain



4L.
Code: 10-710

\$ 33.00

BM5100
Nettoyant professionnel pour les tartre et les taches



EXPLORERS

EXPLORATEURS

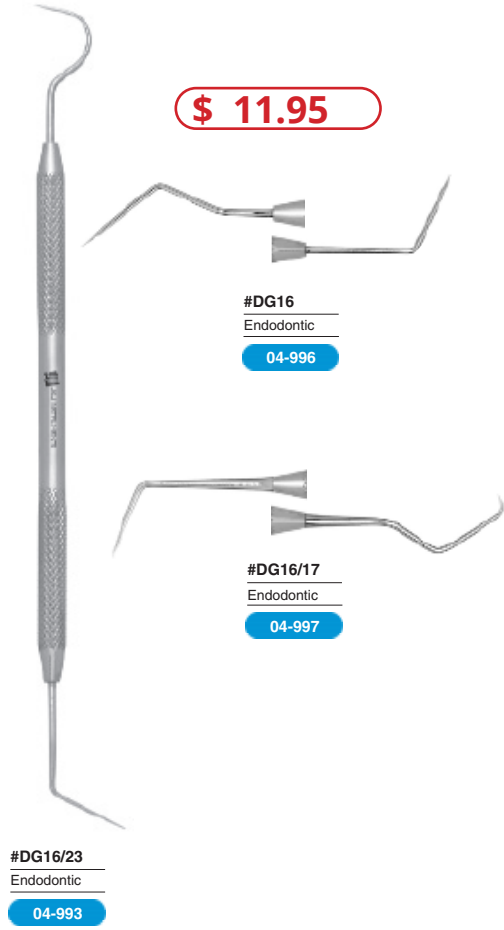
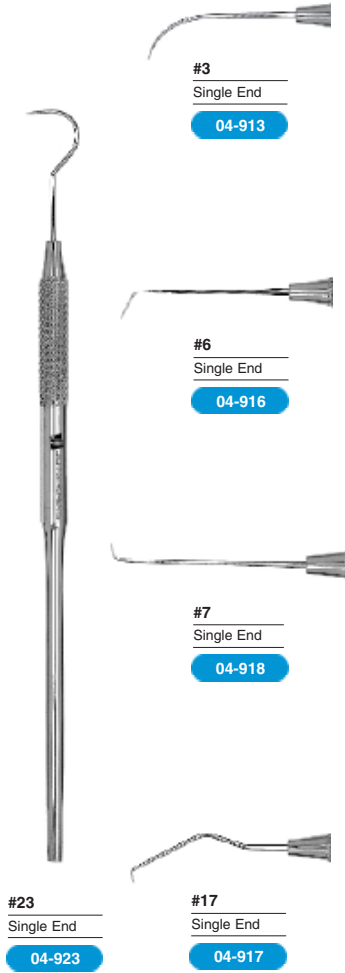
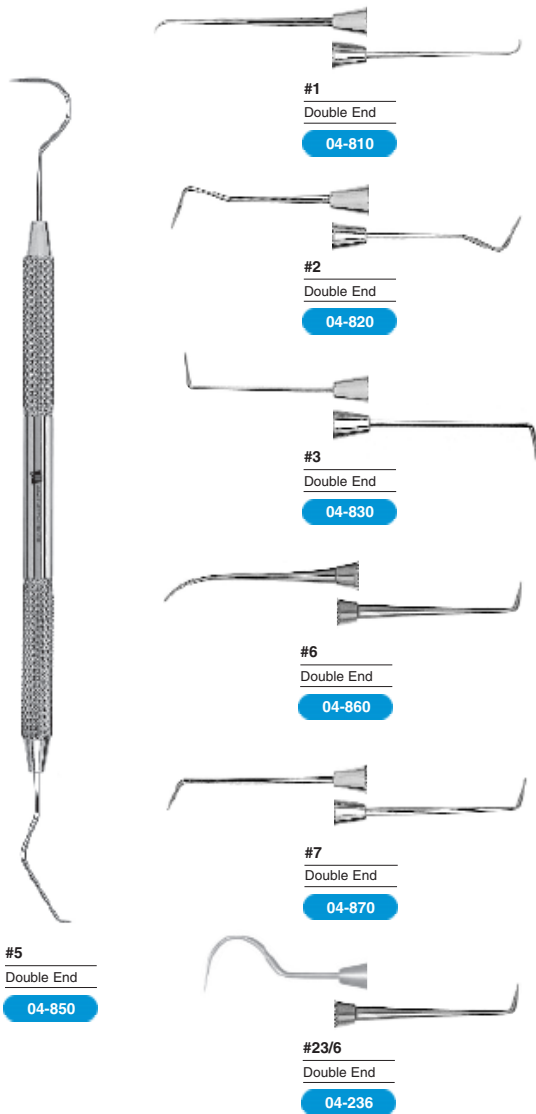

\$ 11.95



COTTON PLIER
PRÉCELLE POUR COTON

Standard:
08-200
08-205
08-255
08-262

\$ 8.95

Self-Locking / Autobloquant
08-210
08-215
08-220
08-250

\$ 11.95



Mouth Mirrors
Cone Socket (CS) #4
07-200 (Rhodium)
07-210 (Chrome)



Mouth Mirrors
Cone Socket (CS) #5
07-230 (Chrome)
07-220 (Rhodium)

**MIRROR HANDLE
MANCHE MIROIR**

07-400
07-405
07-410
07-420

**MIRRORS
MIROIRS**

12/pack - paquet

Chrome **\$24.95**

Rhodium **\$28.95**



Michigan "O" Round
Periodontal Probe
3, 6, 8 mm
16-530

Michigan "OW" Round
with Williams markings
Periodontal Probe
1, 2, 3, 5, 7, 8, 9, 10 mm
16-532

Williams Round
Periodontal Probe
1, 2, 3, 5, 7, 8, 9, 10 mm
16-540

**PROBES
SONDES**

Single end / Bout simple **\$11.95**

Double end / Bout double **\$16.95**

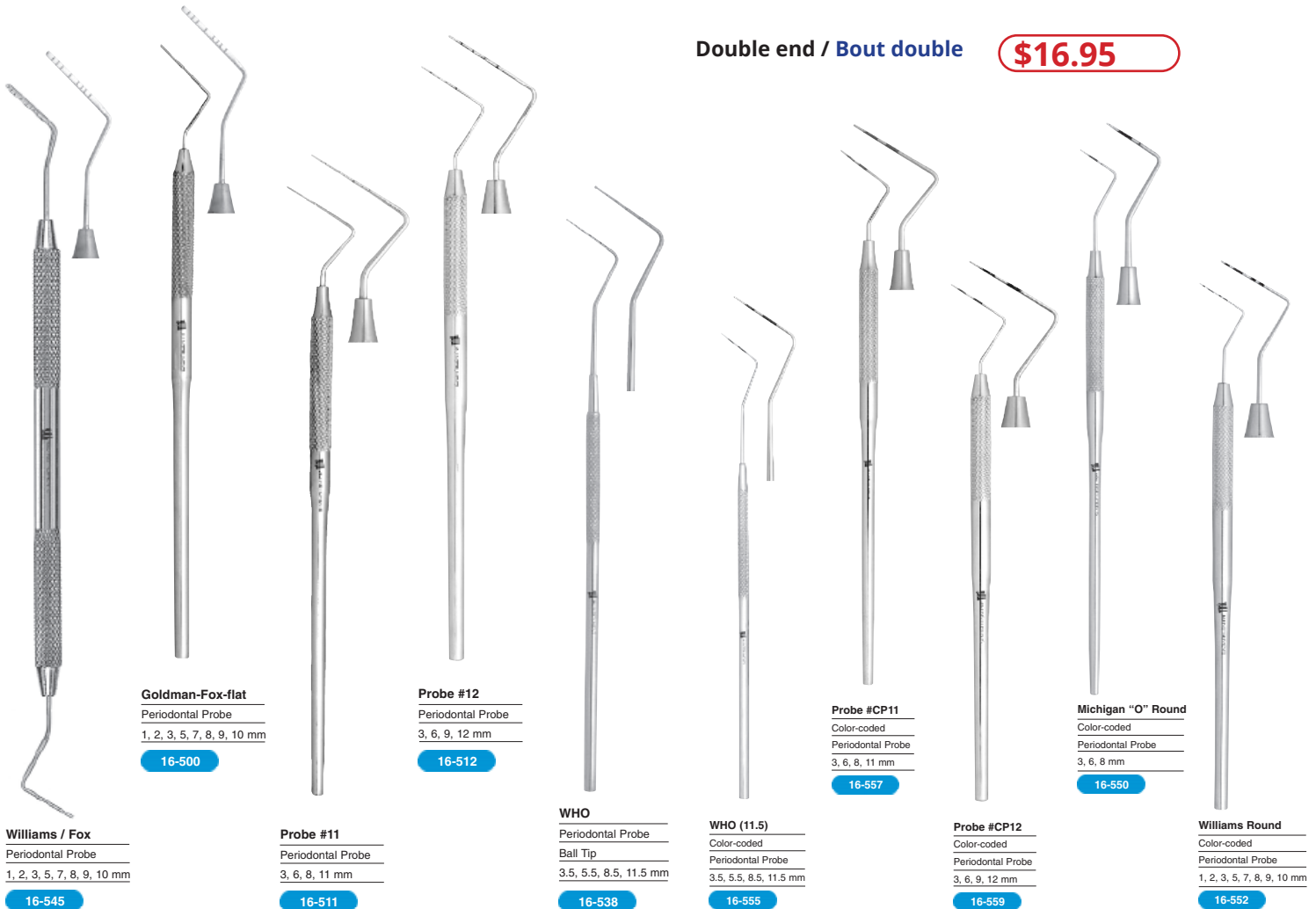

Goldman-Fox-flat
Periodontal Probe
1, 2, 3, 5, 7, 8, 9, 10 mm
16-500

Probe #12
Periodontal Probe
3, 6, 9, 12 mm
16-512

Probe #CP11
Color-coded
Periodontal Probe
3, 6, 8, 11 mm
16-557

Michigan "O" Round
Color-coded
Periodontal Probe
3, 6, 8 mm
16-550

Williams / Fox
Periodontal Probe
1, 2, 3, 5, 7, 8, 9, 10 mm
16-545

Probe #11
Periodontal Probe
3, 6, 8, 11 mm
16-511

WHO
Periodontal Probe
Ball Tip
3.5, 5.5, 8.5, 11.5 mm
16-538

WHO (11.5)
Color-coded
Periodontal Probe
3.5, 5.5, 8.5, 11.5 mm
16-555

Probe #CP12
Color-coded
Periodontal Probe
3, 6, 9, 12 mm
16-559

Williams Round
Color-coded
Periodontal Probe
1, 2, 3, 5, 7, 8, 9, 10 mm
16-552



#23/CP12
Color Coded Expro
3, 6, 9, 12 mm
16-521

EXPROS

\$ 16.95



#23/O
Periodontal Expro
16-524



#23/OW
Periodontal Expro
16-525

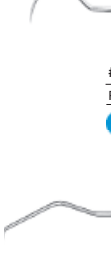

#23/Goldman-Fox
Periodontal Expro
16-526



#23/WHO
Color Coded Expro
3.5, 5.5, 8.5, 11.5 mm
16-519

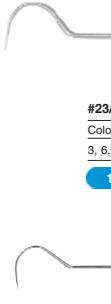

#23/CP11
Color Coded Expro
3, 6, 8, 11 mm
16-520



#23/Williams
Color Coded Expro
1, 2, 3, 5, 7, 8, 9, 10 mm
16-522

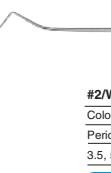

#2/WHO
Color-coded
Periodontal Probe
3.5, 5.5, 8.5, 11.5 mm
16-560



#17/O
Periodontal Expro
16-534



#17/OW
Periodontal Expro
16-535



#17/Goldman-Fox
Periodontal Expro
16-536

**PERIODONTAL PROBES
SONDES PARADONTIE**



Michigan "OW" Round
with Williams markings
Periodontal Probe
1, 2, 3, 5, 7, 8, 9, 10 mm
16-532

\$ 14.55



Michigan "O" Round
Periodontal Probe
3, 6, 8 mm
16-530



Williams Round
Periodontal Probe
1, 2, 3, 5, 7, 8, 9, 10 mm
16-540



Williams / Fox
Periodontal Probe
1, 2, 3, 5, 7, 8, 9, 10 mm
16-545



WHO (11.5)
Color-coded
Periodontal Probe
3.5, 5.5, 8.5, 11.5 mm
16-555



Probe #CP11
Color-coded
Periodontal Probe
3, 6, 8, 11 mm
16-557



Michigan "O" Round
Color-coded
Periodontal Probe
3, 6, 8 mm
16-550



Probe #CP12
Color-coded
Periodontal Probe
3, 6, 9, 12 mm
16-559



Williams Round
Color-coded
Periodontal Probe
1, 2, 3, 5, 7, 8, 9, 10 mm
16-552

SCALERS & CURETTES

CURETTES & DÉTARTREUR



#13/14 9.5mm
Gracey
95-695



#1/2 9.5mm
Gracey
95-612



#9/10 9.5mm
Gracey
95-690



#3/4 9.5mm
Gracey
95-634



#11/12 9.5mm
Gracey
95-694

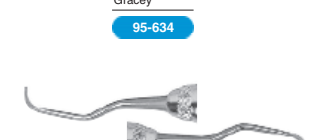

#5/6 9.5mm
Gracey
95-656



#15/16 9.5mm
Gracey
95-696



#7/8 9.5mm
Gracey
95-678

\$ 18.95



#13/14 9.5mm
Columbia
95-742



#4L/4R
Columbia
95-741

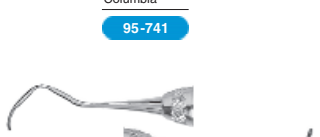

#13/14 9.5mm
McCall
95-750

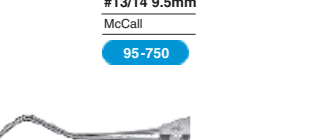

#13S/14S 9.5mm
McCall
95-751



#17/18 9.5mm
McCall
95-752



#17S/18S 9.5mm
McCall
95-753

\$ 18.95



#204S
Scaler
95-204



#S6/S7
Scaler
95-067



#31/32 9.5mm
Jacquette Scaler
95-605



#U15/30
Towner
95-708

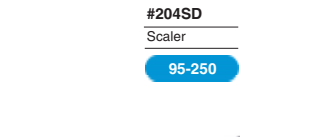

#204SD
Scaler
95-250



#U15/33
Towner
95-714

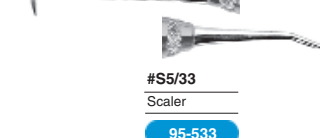

#S5/33
Scaler
95-533



#34/35 9.5mm
Jacquette Scaler
95-603

\$ 18.95

PERIODONTAL PROBES SONDES PARADONTIE



Goldman-Fox-flat
Periodontal Probe
1, 2, 3, 5, 7, 8, 9, 10 mm
16-500

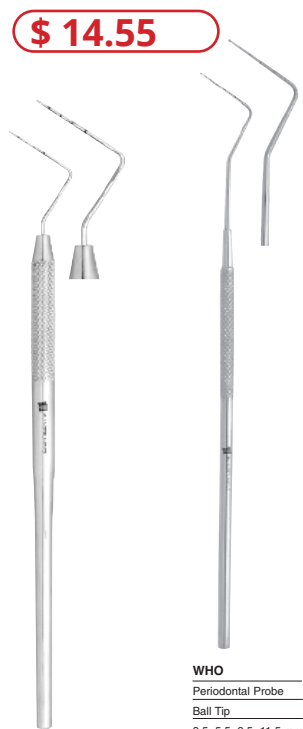

WHO
Periodontal Probe
Ball Tip
3.5, 5.5, 8.5, 11.5 mm
16-538

\$ 14.55

Probe #11
Periodontal Probe
3, 6, 8, 11 mm
16-511

Probe #12
Periodontal Probe
3, 6, 9, 12 mm
16-512

PFI



#3
P.F.I.
08-030



#4/5
Gregg P.F.I.
08-000



#2
Ladmore P.F.I.
08-002



#3
Ladmore P.F.I.
08-003



#1
Woodson P.F.I.
08-101



#2
Woodson P.F.I.
08-102



#3
Woodson P.F.I.
08-103

\$ 15.95

Available in titanium
\$24.95

PFI



#1
P.F.I.
08-010



#2
P.F.I.
08-020



#4
P.F.I.
08-040



#5
P.F.I.
08-050



#11
P.F.I.
08-055

\$ 15.95

Disponible en titane
\$24.95

PFI



#3
P.F.I.
95-030



#2
P.F.I.
95-020



#21B
Acorn Burnisher
95-600



#3
Woodson P.F.I.
95-103



#3S
Hollenback Carver
95-230

\$ 15.95

AMALGAM CARRIER

\$ 22.00

PORTE AMALGAME



DE Reg/Lg
Amalgam Carrier
01-030



DE Reg/Reg
Amalgam Carrier
01-040



DE Reg/Jum
Amalgam Carrier
01-050



DE Lg/Lg
Amalgam Carrier
01-060



DE Jum/Jum
Amalgam Carrier
01-070

EXCAVATORS

#5
Excavator
04-705

#6
Excavator
04-706

#14
Excavator
04-714

#17
Excavator
04-717

#18
Excavator
04-718

#19
Excavator
04-719

#20
Excavator
04-720

#22
Excavator
04-722

#24
Excavator
04-724

#38/39
Excavator
04-738

EXCAVATEURS

#61/62
Excavator
04-761

#33L
Excavator
04-733

#2
Glick
Excavator
04-765

#31LS Spoon
Excavator
04-730

#31L
Excavator
04-731

#32L
Excavator
04-732

\$ 15.95

PLUGGERS
FOULOIRS

\$ 16.00

#1/2 Serrated
Behrman Amalgam
Pluggers
01-220

#0/1 Serrated
Black Plugger
01-210

#0/1 Smooth
Black Plugger
01-215

#1/2 Smooth
Black Plugger
01-225

#2/3 Serrated
Black Plugger
01-240

#2/3 Smooth
Black Plugger
01-245

#4/5 Serrated
Black Plugger
01-246

#4/5 Smooth
Black Plugger
01-247

#9/10
Back Action Plugger
01-200

#11/12
Back Action Plugger
01-205

Smith Special
Amalgam Plugger
08-090

#1
Behrman Amalgam
Plugger
01-010

#1 Serrated
Hollenback Condenser
01-255

#2 Smooth
Hollenback Condenser
01-260

#2 Serrated
Hollenback Condenser
01-265

#1 Smooth
Hollenback Condenser
01-250

0 1 2 3
Black Tip Sizes

\$ 16.00

**Burnishers
Brunissoirs**

#2/3
Burnisher DE
02-501

#26/27S
Burnisher DE
02-505

#29/34
Burnisher DE
02-506

#2/26
Burnisher DE
02-502

#26/29
Burnisher DE
02-508

#2/34
Burnisher DE
02-503

#27/29
Burnisher DE
02-510

#25/26 (13A)
Burnisher DE
02-504

#28/29 Smooth
Burnisher DE
02-500

#21B
Acorn Burnisher DE
02-600

#21
Acorn Burnisher DE
02-522

#21C
Acorn Burnisher DE
02-601

#21D
Acorn Burnisher DE
02-602

#1
U/Michigan Burnisher
02-710

#2
U/Michigan Burnisher
02-720

#1
Ball Burnisher DE
02-610

\$ 14.55

\$ 14.55

#28
Burnisher SE
02-528

#29
Burnisher SE
02-529

#33
Burnisher SE
02-533

#34
Burnisher SE
02-534

#21
Acorn Burnisher SE
02-521

\$ 14.55

**ARTICULATING
PAPER
FORCEPS**

**PINCE POUR
PAPIERS
D'ARTICULATION**

\$ 14.55

Articulating Paper Forceps Straight Serrated
08-300

Articulating Paper Forceps Straight Grooved
08-305

Articulating Paper Forceps Curved Serrated
08-310

\$ 11.18

**CEMENT SPATULA
SPATULE DE CIMENT**

#5
Cement Spatula DE
13-105

#7
Cement Spatula DE
13-107

#26
Cement Spatula DE
13-126

#11S (313)
Cement Spatula
13-110

#22
Cement Spatula
13-122

**CALIPERS & GAUGES
COMPAS D'ÉPAISSEUR**

Boley Millimeter Gauge with Lock
06-800

Wedge Shaped mm Gauge
06-850

Iwansson Spring Caliper Blunt Tip for Wax
06-840

Iwansson Spring Caliper Sharp Tip for Metal
06-841

**CROWN REMOVER
EXTRACTEUR DE COURONNE**

#A Only
Morrell Tip
07-895

#B Only
Morrell Tip
07-896

#C Only
Morrell Tip
07-897

\$ 87.08

W/ A. B. and C Tips
Morrell Crown Remover
07-898

#255
Baade Band Removing Plier
09-255

**RUBBER DAM PUNCH
PINCE POUR DIGUE**

Ainsworth Rubber Dam Punch *
11-500
\$54.00

IV-Type Rubber Dam Punch *
11-550
\$54.00

**RUBBER DAM CLAMP FORCEPS
PINCE DE CRAMPON À DIGUE**

\$ 38.00

Brewer Rubber Dam Clamp FCP *
11-525

IV-Type Rubber Dam Clamp FCP *
11-575

**MATRIX RETAINER
PORTE MATRICES**

\$ 16.29

Reference Universal
07-200

Reference Universal
07-200

Reference Universal
07-200

Reference Universal
07-200

**RUBBER DAM FRAME
CADRE DIGUE DENTAIRE**

\$ 9.95

PERIODONTAL INSTRUMENTS

INSTRUMENTS PARODONTIE



#13/14 9.5mm
Gracey
95-695

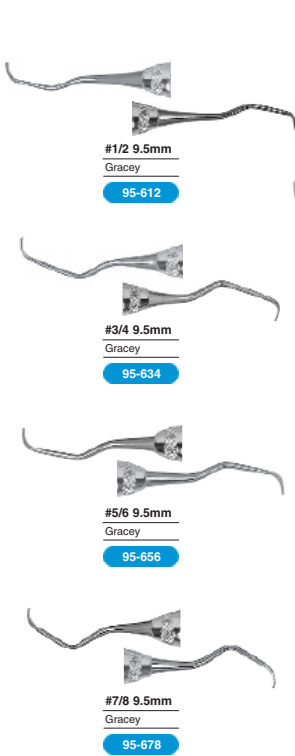

#1/2 9.5mm
Gracey
95-612

#3/4 9.5mm
Gracey
95-634

#5/6 9.5mm
Gracey
95-656

#7/8 9.5mm
Gracey
95-678

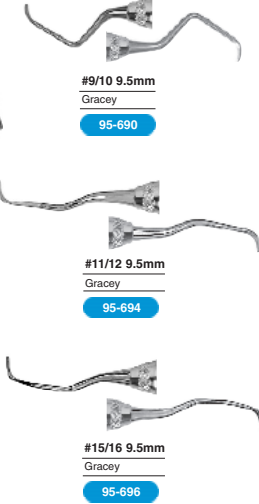

#9/10 9.5mm
Gracey
95-690

#11/12 9.5mm
Gracey
95-694

#15/16 9.5mm
Gracey
95-696

\$19.95



#13/14 9.5mm
Columbia
95-742

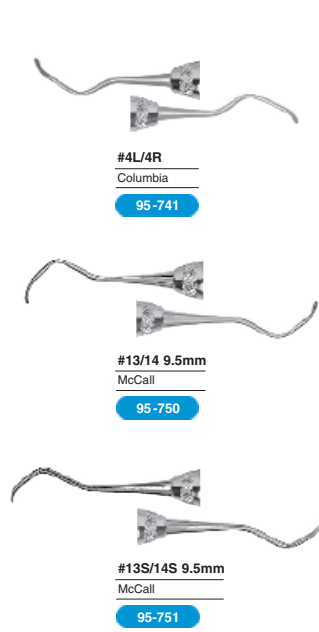

#4L/4R
Columbia
95-741

#13/14 9.5mm
McCall
95-750

#13S/14S 9.5mm
McCall
95-751

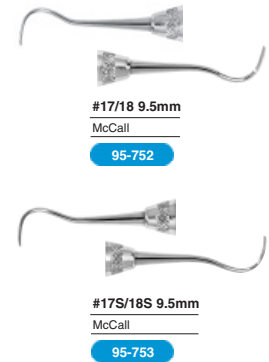

#17/18 9.5mm
McCall
95-752

#17S/18S 9.5mm
McCall
95-753

\$19.95



#204S
Scaler
95-204

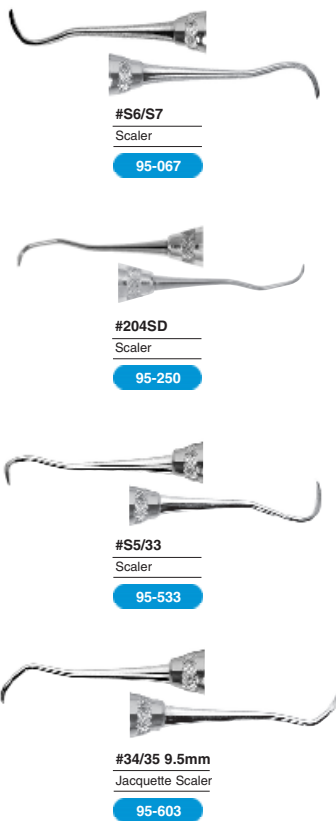

#S6/S7
Scaler
95-067

#204SD
Scaler
95-250

#S5/S33
Scaler
95-533

#34/35 9.5mm
Jacquette Scaler
95-603

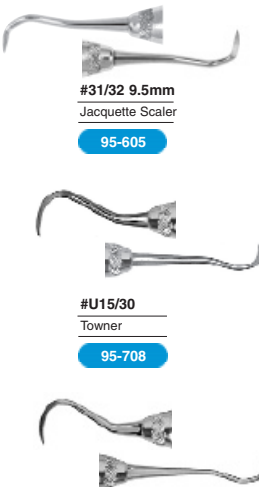

#31/32 9.5mm
Jacquette Scaler
95-605

#U15/30
Towner
95-708

#U15/33
Towner
95-714

\$19.95



4" 4mm
Goldman-Fox
42-2710



4" 8mm
Goldman-Fox
42-2720



4" 12mm
Goldman-Fox
42-2730



Lester
Pumice Cup
07-940

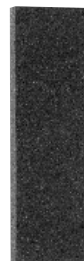

Silicon Carbide
Sharp Stone
99-100



Ceramic Medium Grit
Red Stone
99-300



India Fine Grit
Sharp Stone
99-400



Arkansas Flat Fine
Grit Stone
99-200

EXTRACTION FORCEPS
DAVIERS D'EXTRACTION



\$47.75

#3FH
Woodward Lower 1st & 2nd Molar
Universal Horn Beak Hook Handle

05-034



#5
Lower 3rd Molar
Universal

05-050



#6
Splitting & Separating

05-060



\$47.75

#10H
Upper Molar
Universal Hook Handle

05-100



#10S
Upper Molar
Universal Straight Handle

05-105



#15
Lower 1st & 2nd Molar
Universal Hook Handle

05-150



#16
Lower 1st & 2nd Molar
Universal Hook Handle

05-160



\$47.75

#16S
Child Lower 1st & 2nd Molar
Universal Hook Handle

05-165



#17
Lower 1st & 2nd Molar
Universal Straight Handle

05-170



#18L
Upper 1st & 2nd Molar Left
Hook Handle

05-180



#18R
Upper 1st & 2nd Molar Right
Hook Handle

05-185



#23
Lower 1st & 2nd Molar
Horn Beak Straight Handle

05-230

\$47.75

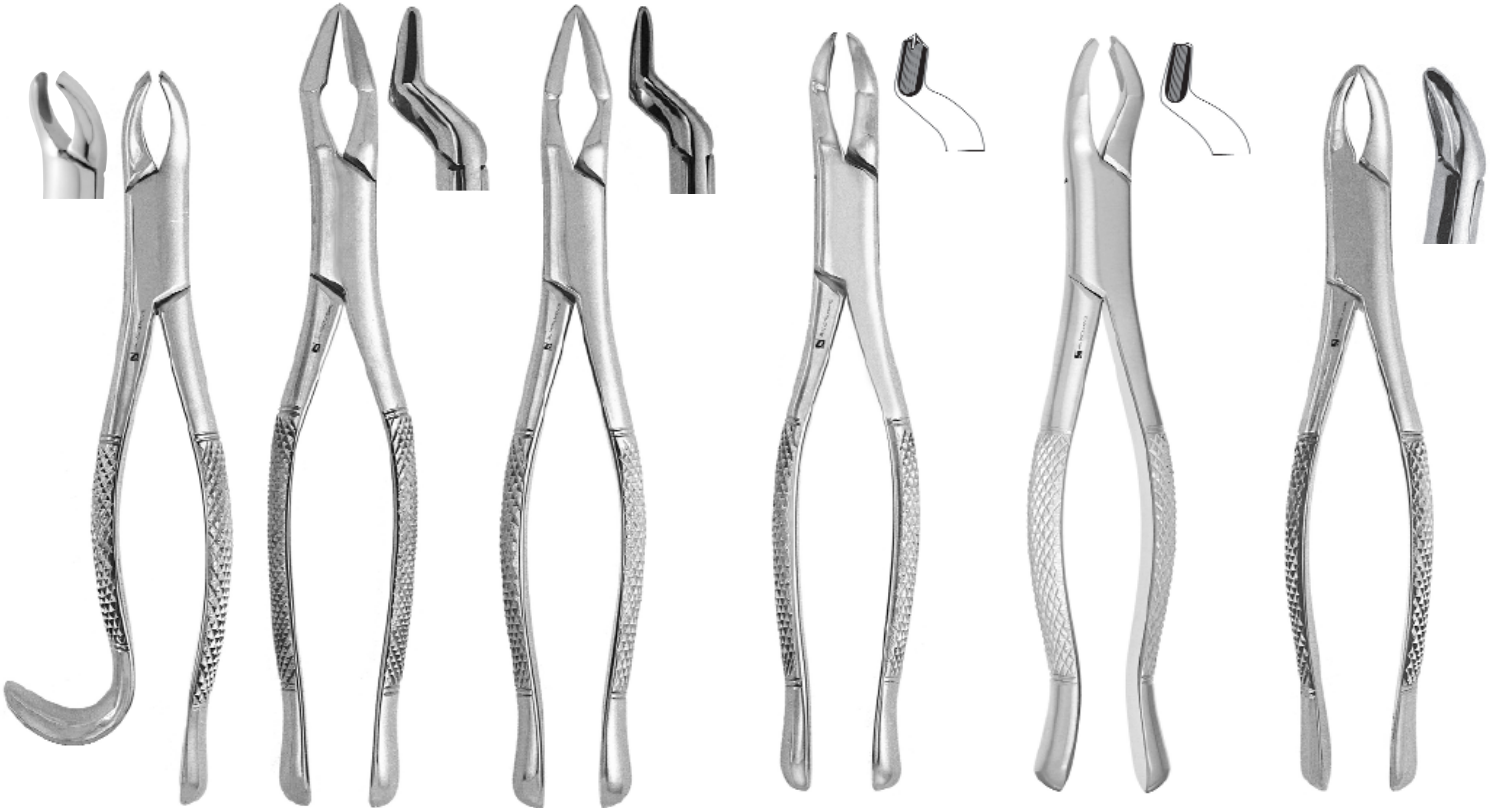

#24
Upper Molar Universal
Hook Handle
05-240

#32
Upper Universal
Bayonet-Bicuspid, Molar
05-320

#32A
Upper Universal
Bayonet-Bicuspid, Molar
05-321

\$47.75

#53L
Upper 1st & 2nd Molar
Bayonet Left
05-530

#53R
Upper 1st & 2nd Molar
Bayonet Right
05-535

#62
Upper or Lower Universal
Incisor, Bicuspid, Deciduous
05-620



#65
Upper Bicuspid Incisor
Root Bayonet
05-650

#69
Upper or Lower
Fragment or Small Root
05-690

#85
Lower Molars Cuspids
Bicuspid
05-850

\$47.75

#85A
Lower Molars Cuspids
Bicuspid
05-851

#88L
Upper Left
1st & 2nd Molar
05-880

#88R
Upper Right
1st & 2nd Molar
05-885



#89
Upper Right Molar
05-890



#90
Upper Left Molar
05-900



#99A
Upper Incisor, Bicuspid,
Cuspid
05-991



#99C
Upper Incisor, Bicuspid,
Cuspid
05-993

\$47.75



#101
Upper or Lower Universal
Bicuspid Deciduous
06-101



#103
Universal Bicuspid
Incisor Root
06-103



#150
Upper Incisor
Bicuspid Root Universal
06-150



#150 Serrated
Upper Incisor
Bicuspid Root Universal
06-156



#150S Child
Universal Bicuspid
Root Upper
06-154



#150A
Universal Incisor
Bicuspid Upper
06-152



#151
Universal Bicuspid
Root Lower
06-151



#151 Serrated
Universal Bicuspid
Root Lower
06-157



#151A
Universal Incisor
Bicuspid Lower
06-153



#151S Child
Universal Incisor
Bicuspid Lower
06-155

\$47.75

\$47.75



#201
Extracting Forceps
06-201



#203
Universal, Lower Bicuspid,
Incisor Root
06-203



#210
Universal, Upper Molar
06-210



#210S
Universal, Upper Molar
06-211

\$47.75



#217
Universal
1st & 2nd Lower Molars
06-217



#222
Universal
Lower 3rd Molar
06-222

\$47.75



#286
Upper Bicuspid
Incisor Root, Bayonet
06-286



#287
Universal
Lower 1st & 2nd Molar
06-287



#288
Lower, Bicuspid, Cuspid
06-288

\$47.75



English #73
Lower Molar
05-730



English #74
Lower Root
05-740



English #74N
Lower Root
05-745



\$47.75

English #13
Lower Bicuspid
05-130

English #22
Lower Molar
05-220

English #33
Lower Root
05-330

#MD1
Universal Upper, Central,
Lateral, Cuspid, Bicuspid
06-321

#MD2
Universal Upper
1st, 2nd, 3rd Molar
06-322

#MD3
Universal Lower
Incisor, Cuspid, Bicuspid, Root
06-323

#MD4
Universal Lower
1st, 2nd, 3rd Molar
06-324

**ELEVATORS
ELEVATEURS**

\$33.15



Apical #302
Elevator
04-402

Apical #303
Elevator
04-403

Apical #304
Elevator
04-404

Bayonet #1
Elevator
04-201

Bayonet #2
Elevator
04-202

Apical #301
Elevator
04-401

Crane Pick #41
Elevator
04-341

Cryer #45
Elevator Small Right
04-945

Cryer #26
Elevator Medium
04-926

Cryer #32
Elevator Large
04-332

Seldin #1L
Elevator
04-520

Cryer #44
Elevator Small Left
04-944

Cryer #25
Elevator Medium
04-925

Cryer #31
Elevator Large
04-331

Seldin #1R
Elevator
04-540

**ELEVATORS
ELEVATEURS**



Seldin #3
Elevator
04-903



Seldin #4L
Elevator
04-560



Heidbrink #1
Elevator
04-901



Heidbrink #40
Elevator
04-940



Heidbrink #80
Elevator
04-980



Seldin #4R
Elevator
04-580



Heidbrink #2
Elevator
04-902



Heidbrink #41
Elevator
04-941



Schmeckeblie #81
Elevator
04-961



Howard #2
Elevator
04-982



Schmeckeblie #4
Elevator
04-964



Miller #71
Elevator
04-971



Miller #73
Elevator
04-973



Howard #1
Elevator
04-981



Howard #3
Elevator
04-983



Schmeckeblie #5
Elevator
04-965



Miller #72
Elevator
04-972



Miller #74
Elevator
04-974

\$33.15



Spear #36
Elevator
04-336



Universal #50
Elevator
04-350



General #190
Elevator
04-990



Gouge #34
Elevator
04-334



Gouge #46
Elevator
04-346



Stout #11A
Elevator
04-914



Universal #51
Elevator
04-351



General #191
Elevator
04-991



Gouge #34S
Elevator
04-335



Stout #11
Elevator
04-912

\$33.15



#11L
Cross-Bar Elevator
04-953

\$33.15



#11R
Cross-Bar Elevator
04-954



#12L
Cross-Bar Elevator
04-955



#12R
Cross-Bar Elevator
04-956



#14L
Cross-Bar Elevator
04-957



#14R
Cross-Bar Elevator
04-958



Potts #1
Cross-Bar Elevator
04-591

Potts #2
Cross-Bar Elevator
04-592

\$31.46



Heidbrink #2/3
Root Tip Pick
04-200



Heidbrink #1
Root Tip Pick
04-210



Heidbrink #2
Root Tip Pick
04-220



Heidbrink #3
Root Tip Pick
04-230



Root Tip #78
Elevator
04-378



Root Tip #79
Elevator
04-379



Root Tip #80
Elevator
04-380



Root Tip #341
Elevator
04-934

\$31.46



Stieglitz 90° Tip
Fragment Forceps 5"
04-389



Stieglitz Straight Tip
Fragment Forceps 5"
04-390



Stieglitz 45° Tip
Stieglitz Fragment Forceps 5"
04-385

\$31.46

**PERIOSTEAL ELEVATORS
ÉLÉVATEURS PÉRIOSTIQUES**



Freer
Periosteal Elevator
04-100



Molt #9
Periosteal Elevator
04-120



Goldman-Fox #14
Periosteal Elevator
04-130



OHL
Periosteal Elevator
04-140



Seldin #23
Periosteal Elevator
04-160



West #2
Periosteal Elevator
04-180

**RETRACTORS
RETRACTEURS**



#2 Austin Cheek Retractor
07-500



U/Minnesota Cheek Retractor
07-505

\$18.56

**BLADE HANDLE
MANCHES DE LAMES**

\$11.50



#3
For Blades 10, 11, 12, 12B, 15, 15C
Scalpel Handle
19-3000



#4
For Blades 20-23
Scalpel Handle
19-4000



#7
Scalpel Handle
19-7000

**MOUTH GAUGE
OUVRE-BOUCHES**



Silicon Replacement Tips
For Molt Mouth Gags
07-905



Molt Mouth Gag
Child
07-900



Molt Mouth Gag
Adult
07-910

**SCISSORS
CISSEAUX**

\$25.28



Kelly 6.25"
Straight Scissor
12-215

Kelly 6.25"
Straight Scissor w/ 1 Serrated Blade
12-275



Kelly 6.25"
Angled Scissor
12-195

Kelly 6.25"
Angled Scissor w/ 1 Serrated Blade
12-255



Kelly 6.25"
Curved Scissor
12-235

Kelly 6.25"
Curved Scissor w/ 1 Serrated Blade
12-295

\$25.28



Iris 4.5"
Straight Scissor
22-1600



Iris 4.5"
Curved Scissor
22-1610



La Grange 4.5"
Curved Scissor
22-1640



Castroviejo 4.75"
Curved Scissor
22-1595



Mayo 5.5"
Straight Scissor
22-1600



Mayo 5.5"
Curved Scissor
22-1605



Spencer 3.5"
Stitch Scissor
23-3010



Littauer 4.5"
Stitch Scissor
23-3040



Shortbent 3.5"
Stitch Scissor
23-3030

\$25.28

\$25.28



Northbent 4.75"
Curved Stitch Scissor
23-3085



4.75"
Angled Wire Cutting Scissor
23-4050



Lister 5.5"
Bandage Scissor
23-4260



Lister 3.5"
Bandage Scissor
23-4200



Lister 4.5"
Bandage Scissor
23-4230



Lister 7.25"
Bandage Scissor
23-4270



Littauer 5.5"
Stitch Scissor
23-3060



6.25"
Extra Long Stitch Scissor
23-3070

\$25.28

HEMOSTAT
PINCES HÉMOSTATIQUES

\$22.64



NEEDLE HOLDER
PORTE AIGUILLES

\$24.72

\$24.72

\$55.06



\$24.72

\$24.72

\$55.06



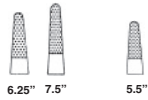

Olsen-Hegar 6.25"
Tungsten Carbide Needle Holder
65-6540

Olsen-Hegar 7.5"
Tungsten Carbide Needle Holder
65-6550

\$55.06



Mayo-Hegar 7" Gator Grip™
Tungsten Carbide Needle Holder
65-6370

\$66.97



Mathieu 5.5" Gator Grip™
Delicate Carbide Needle Holder
65-7655

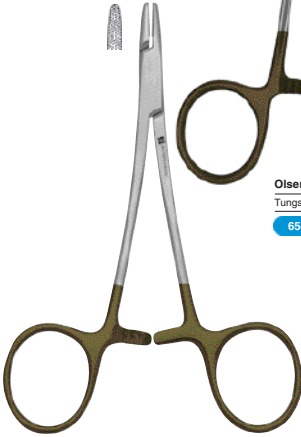

Olsen-Hegar 5.5"
Tungsten Carbide Needle Holder
65-6530



Mayo-Hegar 8" Gator Grip™
Tungsten Carbide Needle Holder
65-6380



Mathieu 5.5" Gator Grip™
Tungsten Carbide Needle Holder
65-7650



Mathieu 4.75" Gator Grip™
Delicate Carbide Needle Holder
65-7680

Derf 4.75" Gator Grip™
Tungsten Carbide Needle Holder
Serrated Jaws
65-6000

Mayo-Hegar 6" Gator Grip™
Tungsten Carbide Needle Holder
65-6360

\$55.06



Crile-Wood 6" Gator Grip™
Tungsten Carbide Needle Holder
65-6420

\$66.97



Boynton 5" Gator Grip™
Tungsten Carbide Needle Holder
65-7550



Castroviejo 5.75" Gator Grip™
Tungsten Carbide Needle Holder
65-7850

\$55.06



Castroviejo 7" Gator Grip™
Tungsten Carbide Needle Holder
65-7875



Mayo-Hegar 5.5" Gator Grip™
Tungsten Carbide Needle Holder
65-6300

CROWN SCISSOR

CISSEAUX DE COURONNES

\$14.95



TISSUE FORCEPS
PINCE DE TISSUS

\$14.95



BONE FILE

LIME D'OSS

\$14.95

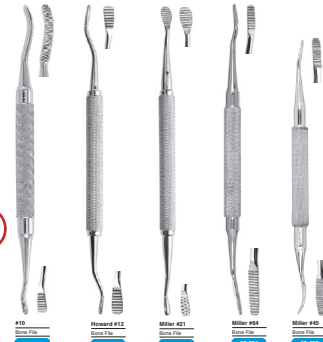

BONE CURETTE

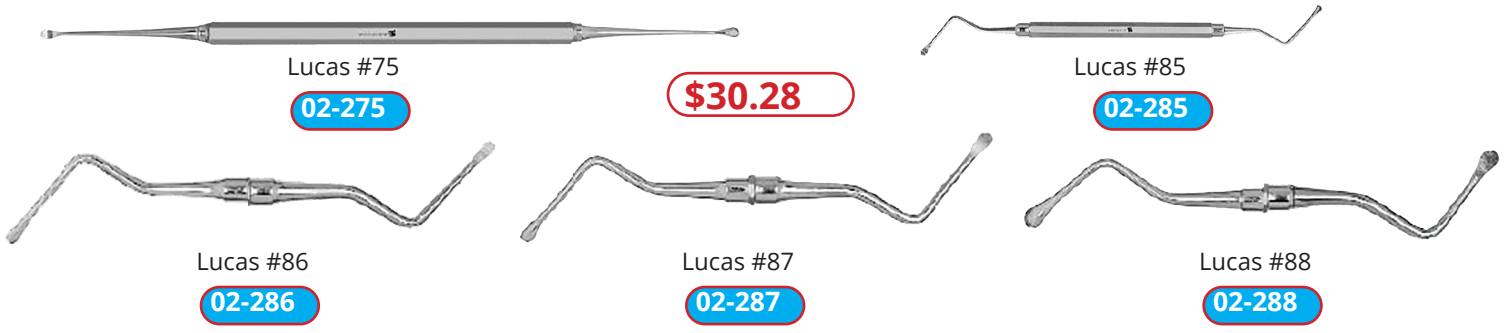

BONE CHISEL



**LAS STONE & PLASTER
PIERRE DE LABORATOIRE**



**PUMICE
PIERRE PONCE**

Hydrocal 105
yellow stone



Hydrocal 105
Pierre jaune

Hydrocal 106
white stone

Hydrocal 106
pierre blanc

HYDROCAL 105
10LBS Code: 12-109 **\$20.67**
50LBS Code: 12-110 **\$71.91**

HYDROCAL 106
10LBS Code: 12-108 **\$20.79**
50LBS Code: 12-107 **\$73.03**

Coarse
Medium
Fine
Flour



Coarse
Moyen
Fin
Flour

5lbs.
Code: 12-106

\$ 19.95

**SPLINT SHEETS
FEUILLES POUR ATTELLE**



**MICRO TORCH
MICRO TORCHES**

Clear
5" x 5"
Thickness:
0.06' or 0.08"



Clair
5" x 5"
Épaisseur
0.06' or 0.08"

20/box - boîte
Code: 12-105

\$ 31.47

Electronic
Removable base
Butane refill



Electronique
Base détachable
Rechargeable au butane

Code: 12-111

\$ 57.95

**ALUMINUM OXIDE
OXIDE D'ALUMINIUM**



27 Microns
50 Microns
90 Microns



27 Microns
50 Microns
90 Microns

1LB.
Code: 12-105

\$ 22.00



**WAX KNIFE
COUTEAUX POUR CIRE**

Fahnestock
5'
6'



Fahnestock
5'
6'

Code: 12-113

\$ 8.95

**PLASTER KNIFE
COUTEAUX DE PLÂTRE**



**PLASTER SPATULA
SPATULE DE PLÂTRE**

#6 - 1.625" Blade
#7 - 1.5" Blade
#8 - 2" Blade
#12 - 2" Blade



#6 - 1.625" Lame
#7 - 1.5" Lame
#8 - 2" Lame
#12 - 2" Lame

Code: 12-102

\$ 14.21

#3R - 3.75" Stiff Blade
#8R - 4" Stiff Blade
#10R - 4.25", Extra Stiff
#11R - 3.5" Flexible



#3R - 3.75" Lame dur
#8R - 4" Lame dur
#10R - 4.25", Extra dur
#11R - 3.5" Flexible

Code: 12-112

\$ 14.02

BAUSCH ARTICULATING PAPERS
PAPIERS D'ARTICULATION



Extremely thin
Tear resistance



Extrêmement minces
Résistants à la déchirure

BK09

Code:13-103

\$ 23.97

BK05

Code: 13-104

\$ 27.79

BK61

Code: 13-105

\$ 14.55

MYNOL ARTICULATING PAPERS
PAPIERS D'ARTICULATION



Thin blue
X-Thin blue
Thick blue
Thin red



Mince bleu
X-Mince blue
Épais blue
Mince rouge

Code: 13-107

\$ 26.97

ARTICULATING PAPERS
PAPIERS D'ARTICULATION



TPXXT XX Thin
TPXT Extra Thin
TPT Thin
TPTH Thick
TPBR Combo



TPXXT XX Mince
TPXT Extra Mince
TPT Mince
TPTH Épais
TPBR Combo

Code: 13-106

\$ 10.07

parkell ACCUFILM® II

S017 Red/Black
S018 Black/Black
S021 Red/Red



S017 Rouge/Noir
S018 Noir/Noir
S021 Rouge/Rouge

Code: 13-108

\$ 35.97

ARTICULATING PAPERS
PAPIERS D'ARTICULATION



53002 Thick blue
53000 Thin blue
53004 Red/Blue
53006 Horseshoe



53002 Épais bleu
53000 Mince bleu
53004 Rouge/bleu
53006 Fer à cheval

Thick/Thin
Code: 13-109

\$ 9.95

Horseshoe
Code: 13-110

\$ 12.95



OCCLUDE®

Recommended for both
chair side and lab use



Pour utiliser à la chaise
ou dans le laboratoire

Green OR Red

Vert OU Rouge

23gm.
Code: 13-111

\$ 24.50

100 tips - embouts
Code: 13-112

\$ 17.37

GETZ® ORIGINAL RETAINER
PORTE MATRICES ORIGINALE



20016453 Universal
20016455 Contra-Angle



20016453 Universel
20016455 Contra-Angle

Code: 13-138

\$ 54.00

J&J INSTRUMENTS
MATRIX RETAINER
PORTE MATRICES

07-300 Adult universal
07-310 Adult contra-angle



07-300 Adult universel
07-310 Adult contra-angle

Code: 13-137

\$ 14.95

TOFFLEMIRE MATRIX BANDS
BANDES MATRICES



TOFFLEMIRE ULTRA-THIN BANDS
BANDES ULTRA-MINCE

- 0.0015" / 0.002"
No.1 Adult Universal
No.2 Adult MOD Wide
No.3 Adult MOD Narrow
No.13 Pedo Universal



- 0.0015" / 0.002"
No.1 Adult Universel
No.2 Adult MOD Large
No.3 Adult MOD étroit-
No.13 Pedo Universel

144/pack - paquet
Code: 13-113

\$ 12.95

- 0.001"
Regular
Dead soft



- 0.001"
Régulier
Ultra-doux



144/pack - paquet

Regular
Code: 13-115

\$ 17.95

Dead Soft
Code: 13-114

\$ 19.10

TEMREX MATRIX ROLLS
ROULEAU DE MATRICES

- 0.0015"
10'
with dispenser
103 #1/4 .0015
104 #3/16 .0015
105 #3/16 .002
107 #1/4 .002



- 0.0015"
10'
avec distributeur
103 #1/4 .0015
104 #3/16 .0015
105 #3/16 .002
107 #1/4 .002

Code: 13-122

\$ 12.00

TEMREX T-BAND
BANDES-T

- 91 Straight Small
92 Straight Large
93 Straight Ass.
94 Curved Small
95 Curved Large
96 Curved Ass.

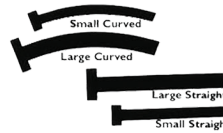

- 91 Droit Petit
92 Droit Large
93 Droit Ass.
94 Courbé Petit
95 Courbé Large
96 Courbé Ass.

100/pack - paquet
Code: 13-121

\$ 12.00

T-BAND BRASS
LAITON T-BANDES

- BTBS/N:
Straight /Narrow (5/32")
BTBC/N:
Curved/Narrow (5/32")



- BTBS/N:
Droit/Étroit (5/32")
BTBC/N:
Courbé/Étroit (5/32")

100/box - boîte
Code: 13-121

\$ 16.71

Danville CONTACT MATRIX™

- 91074 Ultra Thin Flex Large 100 pk
91139 Ultra Thin Flex Small 100 pk
89434 Thin Flex Large 100 pk
89432 Thin Flex Small 100 pk
90071 Stiff Flex Large 100 pk
90070 Stiff Flex Small 100 pk
90679 Subgingival 50 pk
93768 Ultra Subgingival 100 pk



Code: 13-124

\$ 54.00

MYLAR STRIPS

- 0.002"
3/8" x 4",
5.8 microns thickness
#57 Straight
#58 Curved



- 0.002"
3/8" x 4",
5.8 microns épaisseur
#57 Droit
#58 Courbé

1000/box - boîte
Code: 13-135

\$ 16.95



CONTOUR MATRIX BANDS
BANDES MATRICES CONTOUR

- 061080-000
0.0015 in - Ultra-thin
(.0375mm)



- 061080-000
0.0015 in - Ultra-Mince
(.0375mm)

50/box - boîte
Code: 13-119

\$ 56.18

GETZ® ORIGINAL TOFFLEMIRE BANDS
BANDES TOFFLEMIRE ORIGINALES



"DEAD-SOFT" ORIGINAL TOFFLEMIRE®
TOFFLEMIRE® ORIGINAL

No.1 Adult Universal
34577-0 .002 in
34578-9 .0015 in
No.2 Adult MOD Wide
34579-7 .002 in
34580-0 .0015 in
No.3 Adult MOD Narrow
34582-6 .0015 in
No.13 Pedo Universal
34584-2 .002 in
34585-0 .0015 in

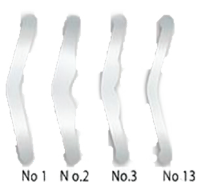

36/pack - paquet
Code: 13-118

\$ 8.95

No.1 Adult Universal
34577-0 .002 in
34578-9 .0015 in
No.2 Adult MOD Large
34579-7 .002 in
34580-0 .0015 in
No.3 Adult MOD Étroit
34582-6 .0015 in
No.13 Pedo Universal
34584-2 .002 in
34585-0 .0015 in

.001 in (.025mm)
34603-6
No.1 Adult Universal
34604-4
No.2 Adult MOD Wide
34605-2
No.13 Pedo Universal

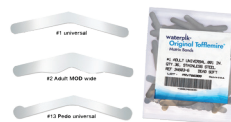

36/pack - paquet
Code: 13-117

\$11.95

PALODENT



659030Y: 50/pack
Large matrices for
subgingival or broadly
extended restorations,

\$59.95

659030Y: 50/paquet
Matrices larges pour
les grosses restaurations
ou sous-gingivale



659020Y 50/pack
Mini matrices pour limited
exposures

\$59.95

659020Y 50/paquet
Matrices mini pour
les restaurations
limitées



659015Y 100/pack
Standard size for most
posterior restorations

\$91.95

659015Y 100/paquet
Grosseur standard pour
les restaurations
régulières

659050 (2/pack - paquet)
Bitine II oval ring Bagues ovales Bitine II

\$31.35

659040 (4/pack - paquet)
Bitine round rings Bagues rondes Bitine

\$57.95

PALODENT PLUS

Matrix Refills

659710 Size 3.5mm (50 Matrices)
659720 Size 4.5mm (50 Matrices)
659730 Size 5.5mm (50 Matrices)
659750 Size 6.5mm (50 Matrices)
659860 Size 7.5mm (50 Matrices)

Recharge Matrices

659710 Taille 3.5mm (50 Matrices)
659720 Taille 4.5mm (50 Matrices)
659730 Taille 5.5mm (50 Matrices)
659750 Taille 6.5mm (50 Matrices)
659860 Taille 7.5mm (50 Matrices)

\$74.95

659740 Size 5.5mm (100 Matrices)

659740 Taille 5.5mm (100 Matrices)

\$128.95

Ring Refills• 2 Rings

659760 2 Universal Rings (Medium Blue)
659770 2 Narrow Rings (Dark Blue)

Recharge Bagues:

659760 2 Bagues universelles (Bleu moyen)
659770 2 Bagues étroites (Bleu foncé)

\$234.95

Wedge Refills• 100 Wedges

659780 Small (Dark Blue)
659790 Medium (Medium Blue)
659800 Large (Light Blue)

Recharges-Coins • 100 Cales Coins

659780 Petit (Bleu foncé)
659790 Moyen (Bleu moyen)
659800 Grand (Bleu pâle)

\$59.95

WedgeGuard Refills

• 50 WedgeGuards
659830 Small (Dark Blue)
659840 Medium (Medium Blue)
659850 Large (Light Blue)

Recharges- Protecteurs de coin

• 50 Protecteurs de coin
659830 Petit (Bleu foncé)
659840 Moyen (Bleu moyen)
659850 Large (Bleu pâle)

\$73.95



Garrison

Dental Solutions

COMPOSI-TIGHT® M-SERIES

Code: 13-129
M050 / M150 / M300
50/pack - paquet
M100 / M175 / M200
100/pack - paquet

\$ 92.00

	Pediatric	Bicuspids	Bicuspids with deep cervical preps	Bicuspids and small molars	Molars	Molars with deep cervical preps
Composi-Tight® 3D bands are contoured in 3 dimensions.						
0,035 mm thin						
Part No.	M050	M100	M150	M175	M200	M300
Height	3.2 mm	4.6 mm	3.8 mm	5.5 mm	6.4 mm	6.4 mm
Quantity	50/Pck.	100/Pck.	50/Pck.	100/Pck.	100/Pck.	50/Pck.

COMPOSI-TIGHT® B-SERIES

Code: 13-130
B050 / B150 / B300
50/pack - paquet
B100 / B200
100/pack - paquet

\$ 79.00

	Composi-Tight Gold® bands are the same as the Composi-Tight® bands.					
0,035 mm thin				N/A		
Part No.	AU050	AU100	AU150	N/A	AU200	AU300
Height	3.2 mm	4.6 mm	3.8 mm		6.4 mm	6.4 mm
Quantity	50/Pck.	100/Pck.	50/Pck.		100/Pck.	50/Pck.

Composi-Tight Gold®

AU050 / AU150 / AU300
50/pack - paquet
AU100 / AU200
100/pack - paquet

\$ 92.00

	Composi-Tight® original bands have a slightly shorter length.					
0,035 mm thin				N/A		
Part No.	B050	B100	B150	N/A	B200	B300
Height	3.2 mm	4.6 mm	3.8 mm		6.4 mm	6.4 mm
Quantity	50/Pck.	100/Pck.	50/Pck.		100/Pck.	50/Pck.

COMPOSI-TIGHT® SYSTEM KIT (K102)

4 - standard G-Rings® (G100)
3 - long-tine G-Rings® (G200)
100 - small bands (B100)
100 - standard bands (B200)
25 - large bands (B300)
1 - ring placement forceps (MRDF-100)



Code: 13-131

\$525.00

4 - G-Rings® Standard (G100)
3 - G-Rings® Longe (G200)
100 - Bandes petites (B100)
100 - Bandes standards (B200)
25 - Bandes larges (B300)
1 - Précelle (MRDF-100)

COMPOSI-TIGHT® RINGS BAGUES



3D XR ring / Bagues: 2/pack - paquet
Code: 13-134

\$269.00

3D Fusion ring / Bagues: 2/pack - paquet
Code: 13-133

\$269.00

G-WEDGE™

GWYL X-Small Yellow
GWBL Small Blue
GWOR Medium Orange
GWGR Large Green



GWYL X-Petit Jaune
GWBL Petit Bleu
GWOR Moyen Orange
GWGR Large vert

300/box-boîte

\$129.00

RING PLACEMENT FORCEPS PINCE D'ANNEAUX

MDRF100
Compatible with all sectional matrices rings and rubber dam clamps



MDRF100
Compatible avec les anneaux de toutes les matrices sectionnelles et les crampon à digue

Code: 13-132

\$109.00

AUTOMATRIX®



- 663002 Narrow Regular
3/16" x .002"
- 663001 Medium Thin
1/4" x .0015"
- 663003 Medium Regular
1/4" x .002"
- 663004 Wide Regular
5/16" x .002"



- 663002 Étroit régulier
3/16" x .002"
- 663001 Moyen mince
1/4" x .0015"
- 663003 Moyen régulier
1/4" x .002"
- 663004 Large régulier
5/16" x .002"

72/pack - paquet
Code: 13-123

\$ 89.00

**SYCAMORE WEDGES
COINS DE BOIS SYCAMORE**



- 9061109 Mini (Light Blue)
- 9061106 UT - Ultra Thin (Orange)
- 9061100 13XT - Extra Thin (Neutral)
- 9061101 13T (Green)
- 9061102 13 (Yellow)
- 9061103 15 (Blue)
- 9061104 16 (Red)
- 9061105 17 (Neutral)
- 9061108 Assorted



400/pack - paquet
Code: 13-141

\$ 64.95

**ANATOMICAL WIZARD WEDGES®
COINS DE BOIS WIZARD® ANATOMIQUES**



**WIZARD WEDGES®
COINS DE BOIS WIZARD®**

- Anatomical
- 061306 Small (natural)
- 061307 Medium (yellow)
- 061308 Large (purple)
- 061309 Extra large (red)
- 061310 Assorted



- Anatomique
- 061306 Petit (naturel)
- 061307 Moyen (jaune)
- 061308 Large (mauve)
- 061309 Extra large (rouge)
- 061310 Assortie

400/pack - paquet
Code: 13-140

\$ 56.95

- 061211 Small
- 061212 Large
- 061213 Slim Jim
- 061214 Wide Base
- 061215 Assorted

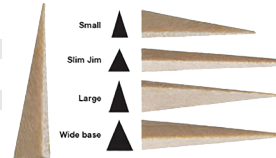

- 061211 Petit
- 061212 Large
- 061213 Slim Jim
- 061214 Base Irge
- 061215 Assortie

500/pack - paquet
Code: 13-141

\$ 56.95

**COMPOSI-TIGHT®
3D FUSION™ WEDGE**



A+WEDGE™

- FXYL X-Small Yellow
- FXBL Small Blue
- FXOR Medium Orange
- FXGR Large Green



- FXYL X-Petit jaune
- FXBL Petit bleu
- FXOR Moyen Orange
- FXGR Large vert

100/pack - paquet

\$ 59.00

- GWAYL X-Small Yellow
- GWABL Small Blue
- GWAOR Medium Orange
- GWAGR Large Green

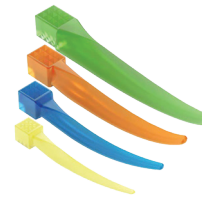

- GWAYL X-Petit jaune
- GWABL Petit bleu
- GWAOR Moyen Orange
- GWAGR Large vert

100/pack - paquet

\$ 65.00

SOFTWEDGE

- WDYL X-Small Yellow
- WDBL Small Blue
- WDOR Medium Orange
- WDGR Large Green



- WDYL X-Petit jaune
- WDBL Petit bleu
- WDOR Moyen Orange
- WDGR Large vert

300/pack - paquet

\$ 85.00

MATRIX PLACEMENT TWEEZER



BFA-1
Each - Chaque

\$ 102.00

MONOJECT NEEDLES METAL HUB
AIGUILLES EN BASE MÉTAL



Monoject™

MONOJECT NEEDLES PLASTIC HUB
AIGUILLES EN BASE PLASTIQUE

8881401072	30 Short x 1" (26mm)	Blue
8881401171	30 X-Short x 1/2" (11mm)	Blue (white cap)
8881401064	27 Short x 1" (26mm)	Yellow
8881401056	27 Long x 13/8" (36.5mm)	Yellow
8881401049	25 Short x 1" (26mm)	Red
8881401031	25 Long x 13/8" (36.5mm)	Red



100/box - boîte
Code: 14-109

\$ 16.95

8881400074	30 Short x 3/4" (21mm)	Blue
8881400173	30 X-Short x 1/2" (11mm)	Blue (white cap)
8881400066	27 Short x 3/4" (21mm)	Yellow
8881400058	27 Long x 11/4" (32mm)	Yellow
8881400041	25 Short x 3/4" (21mm)	Red
8881400033	25 Long x 11/4" (32mm)	Red



100/box - boîte
Code: 14-109

\$ 15.95

ENDODONTIC NEEDLES & SYRINGES
SERINGUES & AIGUILLES ENDODONTIQUES

8881513843
3ml. syringe with 23G x 1 1/4"
(31.7mm) Orange

8881513850
3ml. syringe with 27G x 1 1/4"
(31.7mm) Yellow



100/box - boîte

\$ 52.95

ENDODONTIC NEEDLES
AIGUILLES ENDODONTIQUES

8881471232
23G x 1 1/4" (31.7mm) Orange

8881471273
27G x 1 1/4" (31.7mm) Yellow



25/box - boîte
Code: 14-108

\$ 12.95

CURVED TIP SYRINGES
SERINGUES AVEC EMBOUTS COURBÉS

8881412012 (412)
Curved Tip
12ml.



8881412012 (412)
Embout courbé
12ml.

50/box - boîte
Code: 14-116

\$ 29.95

Fairfax Dental Ltd. STABIDENT

Intraosseous
anesthesia delivery
system



Système de
distribution
d'anesthésiant
intraosseux

20/box - boîte

\$ 69.95

Code: 14-110

100/box - boîte

\$228.00

FLEXI-GLIDE™



Endo irrigation tip
Comparable to Navi-Tip
30G



Embout d'irrigation
endodontique
30G
Comparable à Navi-Tip

50/pack - paquet
Code: 14-112

\$ 74.95



LUER-LOCK SYRINGES
SERINGUES LUER-LOCK

Endodontic irrigation
syringes
3ml. / 6ml. / 12ml.



Seringues
d'irrigation
endodontiques
3ml. / 6ml. / 12ml.

Code: 14-113
3ml.

\$ 19.95

100/box - boîte
Code: 14_114
6ml.

\$ 20.95

Code: 14-115
12ml.

\$ 21.95

ParaPost®



15-101	PARAPOST FIBER LUX (PF171) 5/BOX	\$ 76.95
15-102	PARAPOST FIBER WHITE (PF161) 5/BOX	\$ 76.95
15-1021	PARAPOST TAPER LUX (PF181) 5/BOX	\$ 69.95
15-104	PARAPOST VENTED AND SERRATED POSTS STAINLESS STEEL (P244) 10/BOX	\$115.62
15-105	PARAPOST XH TITANIUM ALLOY (P88) 10/BOX	\$115.62
15-106	PARAPOST XT THREADED ENDODONTIC POSTS (P684)10/BOX	\$179.95

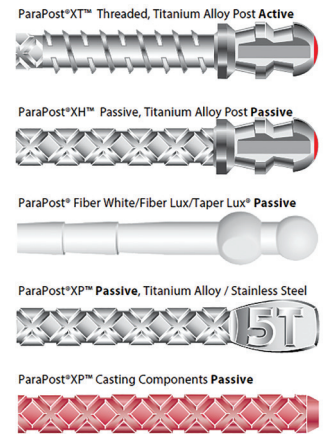

Drills / Forêts (3/pack - paquet) P42
\$94.97

ICEPost™



- 90082-01 IcePost Refill 1.0mm
- 90083-01 IcePost Refill 1.2mm
- 90088-01 IcePost Refill 1.4mm
- 90089-01 IcePost Refill 1.6mm



10/pack - paquet
Code: 15-103

\$139.95



FLEXI-POST®

- Diameter
- #00 0.95mm
- #0 1.07mm
- #1 1.40mm
- #2 1.65mm
- #3 1.90mm



10/pack - paquet
Code: 15-108

\$249.95

STABILOK™



- Stainless Steel
- Small .021" (Blue)
- Medium .027" (Green)
- Titanium
- Small .021" (Yellow)
- Medium .027" (Orange)



- Acier inoxydable
- Petit .021" (Bleu)
- Moyen .027" (Vert)
- Titane
- Petit .021" (Jaune)
- Moyen .027" (Orange)

100/pack - paquet
Code: 15-113

\$169.00

coltène whaledent TMS® LINK PLUS®

Self-threading parapulpal retention pins
Stainless Steel
Bulk kit L732



tenons parapulpaires à autofiletage
Acier inoxydable
Ensemble vrac L732

50/pack - paquet
Code: 15-114

\$469.95

PRECISION PARALLEL POSTS



Comparable to ParaPost XP



Equivalent à ParaPost XP

10/pack - paquet
Code: 15-107

\$ 47.75

TENAX®

Plastic burnout posts P752



Tenons à brûler en plastique P752

30/pack - paquet
Code: 15-117

\$ 52.55

PREVENTIVES

PREVENTIFS

CLINPRO™ SEALANT SCELLANT

Fluoride releasing light
cured pit & fissure sealant



Scellant
photopolymérisable
pour puits et fissures à
libération de fluorure

1.2ml syringe - seringue
Code: 16-101

\$ 32.95

3M

Dentsply
Sirona

CAVITRON® JET-FRESH®

Sodium free prophylaxis
powder



Poudre à prophylaxie sans
sodium

13oz. bottle - bouteille
Code: 16-131

\$ 47.95

SEAL-RITE™ Pit & Fissure sealant Scellant pour puits et fissures

Low viscosity



Basse viscosité

4 x 1.2ml. syringes - seringues
Code: 16-103

\$ 86.00

PULPDENT®
Dental Innovation Since 1947

EMBRACE™ WETBOND™ Pit & Fissure sealant Scellant pour puits et fissures

Hydrophilic resin.
Humidity tolerant



Résine hydrophile et
tolérant à l'humidité

4 x 1.2ml. syringes - seringues
Code: 16-102

\$ 105.62

MICROPROPHY B+ SODIUM BICARBONATE

Green mint flavor
Sodium bicarbonate with
surfactant



Bicarbonate de sodium
Goût de menthe verte,
sans surfactant

1lb. bottle - bouteille
Code: 16-130

\$ 42.00

Danville

CARIES FINDER™

1% Acid Red 52 solution
in a propylene glycol
base.



1% d'acide rouge 52 dans
une base de propylène
glycol.

10ml. bottle - bouteille
Code: 16-129

\$ 59.95

DURAFLO® VARNISH VERNIS

5% Sodium Fluoride,
Bubble Gum



5 % de fluorure de
sodium,
Gomme baloon

10ml. tube
Code: 16-139

\$ 35.96

Medicom®
Pride in Protection

DENTICARE PRO-GEL / PRO-FOAM

2.72% Topical Sodium
Fluoride

Pro-Gel: 10021

Pro-Foam: 10037



2,72 % de fluorure
de sodium

Pro-Gel: 10021

Pro-Foam: 10037

Pro-Gel
480ml.
Code: 16-136

\$ 22.95

Pro-Foam
4.4oz.
Code: 16-137

\$ 42.27

PROPHY CUPS / BRUSHES
CUPULES / BROSSES À PROPHIE

Prophy cups		Cupules à prophie	
16-121	Snap-On à pression	\$11.50	
16-119	Latch Type à loquet	\$20.79	
16-120	Screw-On à vis	\$19.00	
Prophy brush		Brosse à prophie	
16-127	Latch Type à loquet	\$35.96	



FLUORIDE TRAYS
PORTE FLUORURE

Large, Blue
Medium, Yellow
Small, Green

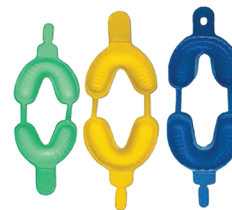

Large, Bleu
Moyen Jaune
Petit Vert

100/pack - paquet
Code: 16-118

\$ 25.28

HAPPY MORNING TOOTHBRUSH
BROSSE À DENTS



Disposable toothbrushes



Brosses à dents jetables

72/box - boîte
Code: 16-114

\$ 39.19



SCRUBBIES TOOTHBRUSH
BROSSE À DENTS

F815 : Adult
F017: Kids



F815: Adult
F017: Enfants

12/pack - paquet
Code: 16-114

\$ 11.50

DISPOSABLE PROPHY ANGLES
ANGLES À PROPHIE JETABLES



#PA-6000 firm (Purple)
#PA-7000 soft (Green)



#PA-6000 dur (Mauve)
#PA-7000 doux (Vert)

100/pack - paquet
Code: 16-128

\$ 58.00

DENTAMERICA® **PROPHY CUPS**
CUPULES À PROPHIE



16-122	PROPHY CUPS LATCH	\$33.65
16-123	PROPHY CUPS SCREW-IN	\$20.50
16-124	PROPHY CUPS SNAP ON	\$15.67

FLOSS & MOUTH RINSE
SOIE DENTAIRE & RINSE BOUCHE



16-108	WAX DENTAL FLOSS SPOOL 200 YD	\$4.95
16-109	FLOSS WAXED MINT PATIENT 12 YDS 144/BOX	\$65.50
16-111	LISTERINE ANTISEPTIC MOUTH-WASH 1.5 L	\$7.95



XTRITIUM CHLORHEXIDINE

0.12% Chlorhexidine Gluconate (CHG) Oral Rinse



Rinse bouche avec 0.12% Gluconate de chlorhexidine (CHG)

473ml. bottle - bouteille
Code: 16-113

118ml. bottle - bouteille
Code: 16-112

\$ 12.92

\$ 5.06

PREVENTIVES

PREVENTIFS

GELATO PROPHY PASTE (JAR) PÂTE À PROPHIE (POT)



Bonvoit Company



- #24-10877 Fine Bubble Gum
- #24-09077 Medium Cherry
- #24-08177 Medium Mint
- #24-08077 Medium Piña Colada
- #24-03977 Coarse Cherry
- #24-04077 Coarse Mint



12 oz. Jar (.35 L) - Pot
Code: 16-135

\$ 17.00

GELATO PROPHY PASTE (UNIDOSE) PÂTE À PROPHIE (UNIDOSE)

- | | |
|----------------------------------|----------------------------------|
| #24-02877 Fine Bubble Gum | #24-02977 Coarse Cherry |
| #24-02377 Medium Bubble Gum | #24-03077 Coarse Mint |
| #24-02477 Medium Cherry | #24-03177 Coarse Piña Colada |
| #24-02277 Medium Mint | #24-11777 Coarse Orange Sherbert |
| #24-02577 Medium Piña Colada | #24-15977 Coarse Raspberry |
| #24-11677 Medium Orange Sherbert | #24-02777 Coarse Assorted* |
| #24-15877 Medium Raspberry | #24-05077 X-Coarse Cherry |
| #24-02677 Medium Assorted* | #24-05177 X-Coarse Mint |
| #24-07577 Coarse Bubble Gum | #24-15177 Propy Ring |

200 Cups (400g/14.1 oz)
Code: 16-133

\$ 38.00

MARK3 PROPHY PASTE (CUPS) PÂTE À PROPHIE (CUPULES)



- | | | |
|------|---------------|-------------------|
| 1620 | Coarse Asst | Grossier assortie |
| 1621 | Coarse B-Gum | Grossier gomme B. |
| 1622 | Coarse Cherry | Grossier ceris |
| 1623 | Coarse Mint | Moyen menthe |
| 1630 | Medium Asst. | Moyen assortie |
| 1633 | Medium Mint | Moyen menthe |



200 Cups (400g/14.1 oz)
Code: 16-134

\$ 42.70

MARK3 PROPHY ANGLES ANGLES À PROPHIE

Compare to Sultan
Upgrade Angles,
Denticator Angles and
Young Angles

- 100-247-144Soft
- 100-248-144Firm



Comparable à Sultan
Upgrade Angles,
Denticator Angles et
Young Angles

- 100-247-144Souple
- 100-248-144Dur

144/box - boîte
Code: 16-128

\$ 58.00

BRIDGEAID®



Dental floss threaders

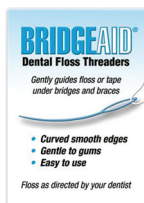

Enfileurs pour soie dentaire

1000/box - boîte
Code: 16-107

\$ 61.80



SUPERFLOSS®

Effectively cleans large
interproximal areas with soft,
spongy floss



La soie douce et spongieuse
nettoie efficacement les
zones interproximales

100/box - boîte
Code: 16-110

\$ 77.53

DENSCO® PROPHY CUPS CUPULES À PROPHIE



- | | | |
|------------|------------------------------|-----------------|
| 085032-144 | Snap-on Soft blue 144/pack | \$ 54.95 |
| 085032-01M | Snap-on Soft blue 1000/pack | \$329.95 |
| 085132-144 | Screw-in Soft blue 144/pack | \$ 63.95 |
| 085132-01M | Screw-in Soft blue 1000/pack | \$339.95 |
| 085232-144 | Latch Soft blue 144/pack | \$ 97.95 |
| 085232-01M | Latch Soft blue 1000/pack | \$499.95 |

DENSCO® PROFLEX FLEXIBLE SCALER DÉTARTAREUR FLEXIBLE

Designed for efficient
interproximal scaling and
stain removal.



Conçus pour enlever les
taches et la plaque den-
taire interproximales.

3 ft. roll / rouleau
Code: 08-133

\$ 35.96

ETCH-RITE™ (Etching Gel)



- 17-101 Jumbo kit 2 x 25ml. with 5 empty syringes of 3ml. **\$71.91**
Ens. Jumbo 2 x 25ml. avec 5 seringues vides de 3ml.
- 17-102 Jumbo refill 2X25ml **\$48.00**
Recharge Jumbo 2 x 25ml.
- 17-103 Bulk pack 24 x 1.2ml. syringes **\$89.00**
Paquet vrac 24 x 1.2ml. seringues

**PORCELAIN PREP KIT
ENS. DE PRÉPARATION POUR PORCELAINE**

Porcelain Etch Gel, Dry-Rite drying agent and silane bond enhancer.



Gel de mordantage pour porcelaine, un agent de séchage Dry-Rite et un matériau d'amélioration du lien au silane.

Code: 17-202

\$ 68.95

PULPDENT®
Dental Innovation Since 1947

**PORCELAIN ETCH GEL
GEL ETCHANT POUR PORCELAINE**

9.6% hydrofluoric acid gel

Acide fluorhydrique à 9,6%



4 x 1.2ml. syringes - seringues
Code: 17-106

\$ 69.95

Silane Bond Enhancer

Single component material that increases bond strength of resin cements and composites to porcelain.



un matériau à un seul composant qui augmente la résistance d'adhésion des ciments résines et des composites à la porcelaine.

3ml. syringe - seringue
Code: 17-201

\$ 33.95

SCOTCHBOND™ UNIVERSAL



One step, one coat adhesive application



Application adhésive en une seule étape et en un seul recouvrement

5ml. bottle - bouteille
Code: 17-203

\$174.95

KERR OPTIBOND UNIVERSAL ADHESIVE

One step, one coat adhesive application



Application adhésive en une seule étape et en un seul recouvrement

5ml. bottle - bouteille
Code: 17-204

\$110.11

ADPER™ SCOTCHBOND™ MULTI-PURPOSE

Classical bonding agent with 3 stages: etch, primer and bonding



L'adhésif classique avec mordantage total, 3 étapes : mordantage, apprêt, adhésif

Primer - Apprêt
8ml.
Code: 17-207

Adhesive - Adhésif
8ml.
Code: 17-206

\$ 69.00

\$ 69.00

ADPER™ SINGLE BOND

Total-etch, single-component bonding agent offering exceptional bond strength.



Adhésif mono composant en mordantage total qui offre une adhésion exceptionnelle

6ml. bottle - bouteille
Code: 17-205

\$ 79.00

OPTIBOND SOLO™ PLUS

Total-etch, single-component dental adhesive.



Adhésif mono composant en mordançage total.

5ml. bottle - bouteille
Code: 17-213

100 unidoses
Code: 17-214

\$148.00

\$298.00



OPTIBOND eXTra

Primer Adhesive



Apprêt Adhésif.

5ml. bottle - bouteille
Code: 17-215

\$122.00

OPTIBOND™ ALL-IN-ONE™

Self-etch, single-component dental adhesive



Adhésif mono-composant auto-mordançant.

6ml. bottle - bouteille
Code: 17-212

\$100.00

OPTIBOND™ FL

Total-etch, two-component dental adhesive



Adhésif mono-composant auto-mordançant

8ml. bottle - bouteille
PRIMER

\$ 123.60

8ml. bottle - bouteille
ADHESIVE

\$107.87

iBOND® TOTAL ETCH

An etch and rinse 2-step adhesive that attains high bond strength to both enamel and dentin



Adhésif amélo-dentinaire M&R2 (en 2 étapes) photopolymérisable.

4ml. bottle - bouteille
Code: 17-210

\$197.75



KULZER
MITSUI CHEMICALS GROUP

GLUMA® BOND

Prime, bond and desensitize in a single no-mix step



Préparer, coller et désensibiliser en une seule étape sans mélange.

4ml. bottle - bouteille
Code: 17-209

\$ 89.00

GLUMA® DÉSENSIBILISANT

indicated for treating cervical hypersensitivity and eliminating dentinal hypersensitivity.



Pour traiter l'hyperesthésie cervicale et pour éliminer l'hyperesthésie.

5ml. bottle - bouteille
Code: 17-211

\$ 88.76



KULZER
MITSUI CHEMICALS GROUP



PRIME & BOND NT

Unique PENTA (adhesion promoter) chemistry and NT (Nanofiller) technology



Chimie unique PENTA (promoteur d'adhésion) et à la technologie NT (Nanoparticules)

3.5ml. bottle - bouteille
Code: 17-208

\$ 66.29

CLEARFIL™ SE BOND

Light-curing bonding system consisting of a self-etching primer and a bonding agent.



Système d'adhésion composante d'apprêt auto-mordant et adhésif

Kit / Ensemble
(Primer+Bond) / (Apprêt & Adhésif)
Code: 17-217

\$212.00

Bond / Adhésif
5ml.
Code: 17-218

\$155.00



CLEARFIL S3 BOND PLUS

Single-step, self-etch, fluoride-releasing bonding agent



Une étape adhésif auto-mordant avec libération de fluorure

5ml.bottle - bouteille
Code: 17-216

\$162.92

Excite F

Filled, light-curing, single-component, fluoride-releasing bonding agent, Etch & Rinse



Adhésif monocomposant photopolymérisable contenant du fluor, nécessitant un mordantage et un rinçage préalables.

5gm.bottle - bouteille
Code: 17-219

\$167.95



ADHESE® UNIVERSAL

Single-component, light-cured universal adhesive



Adhésif monocomposant photopolymérisable universel.

1 x 2ml. Vivapen + 100 cannula
Code: 17-221

\$159.95

1.2ml. vivapen

\$119.00

MONOBOND PLUS

Universal, single-component primer



Apprêt mono-composant universel

5gm.bottle - bouteille
Code: 17-220

\$119.10



TRANSBOND™ XT

Direct Bond Light Cure Adhesive.



Adhésif direct photopolymérisable

Transbond LR Capsules
25 capsules (0.2 g each)
712-038

\$282.00

2 syringes (4 g each)
6 ml primer
712-035

\$158.00

4 syringes (4 g each)
712-036

\$262.92

ALL-BOND UNIVERSAL

Single-component Light cure adhesive



Adhésif dentaire photopolymérisable mono-composant

B-7202P
6ml. Bottle - bouteille

\$144.16



Z-PRIME PLUS

Single-component priming agent

Zirconia - Alumina - Metal Primer
Zircrone-Alumine-Apprêt pour Métal



Apprêt mono-composant

B-6001P
4ml. Bottle - bouteille

\$ 99.95

RESTORATIVES (COMPOSITE)

RESTAURATIONS (COMPOSITE)

FILTEK™ SUPREME ULTRA

Universal nanocomposite



Nano-composite universel

20 x 0.2gm. compules
1 x 4gm. syringe - seringue
Code: 17-301

\$143.82



Z100™ RESTORATIVE

Light-cured hybrid composite resin



Résin composite hybride photopolymérisable

18 x 0.2gm. compules
Code: 17-302

\$ 87.64

4gm. syringe - seringue
Code: 17-303

\$ 99.95

FILTEK™ Z250

Universal dental composite resin



Résin composite universel

20 x 0.2gm. compules
Code: 17-304

\$ 89.95

4gm. syringe - seringue
Code: 17-305

\$ 59.95

FILTEK™ UNIVERSAL

Comparable to Filtek Supreme Ultra



Comparable à Filtek Supreme Ultra

20 x 0.2gm. compules
Code: 17-306

\$ 124.00

FILTEK™ P60

Posterior Restorative A3 / B2



Restauration postérieur A3 / B2

4gm. syringe - seringue
Code: 17-308

\$ 53.93

FILTEK™ BULK FILL POSTERIOR

Placement in one easy step up to 5mm. depth



Placement dans une seule étape profondeur de 5mm.

20 x 0.2gm. compules
Code: 17-309

\$103.93

4gm. syringe - seringue
Code: 17-3091

\$ 94.38

FILTEK™ BULK FILL FLOWABLE

Easy adaptation in deep posterior restorations with little or no instrumentation.



Adaptation facile dans la grosse restauration postérieur avec ou sans instrumentation.

15 x 0.2gm. compules

\$103.97

3gm. syringe - seringue

\$102.81

FILTEK™ FLOWABLE

Flowable universal composite



Composite universel fluide

2 x 2gm. syringe - seringue

\$ 76.97

PROFIL™

Micro Hybrid Composite Resin offers the latest in Nano Technology.



20 x 0.2gm. compules
Code: 17-310

\$ 71.85

Composite micro hybride avec le technologie nano

4gm. syringe - seringue
Code: 17-311

\$ 43.82

SILMET PROFIL™ FLOW

Light activated, radiopaque, flowable composite



4gm. syringe - seringue

\$ 54.49

Composite fluide radiopaque et photopolymérisable

ESTHET-X® HD

High definition micro matrix restorative provides realistic restorations for outstanding results for a all cavity classifications.



20 x 0.25g. Compules
Code: 17-312

\$110.11

Restauration à micro-matrice de haute définition donne des restaurations d'un réalisme exceptionnel pour tous genres de cavités

Dentsply Sirona SPECTRUM TPH3

Light-activated, radiopaque microhybrid composite for anterior and posterior restorations.



20 x 0.25g. Compules
Code: 17-313

\$ 99.95

Composite microhybride radiopaque et photopolymérisable pour les restaurations antérieures et postérieures

CHARISMA®

Hybrid composite that allows natural restorations with minimal effort.



4gm. syringe - seringue
Code: 17-314

\$ 43.82

Composite hybride qui donne une restauration normale avec un effort minimal.

KULZER VENUS® PEARL

Universal nano-hybrid composite



20 x 0.2g. Compules
Code: 17-315

\$110.11

Composite universel nano-hybride

Wave / Wave MV / Wave HV

Composite flowable with 3 viscosities



1gm. syringe - seringue
Code: 17-408

\$ 14.04

Composite fluide avec 3 viscosités

SDI RIVA LC

The glass ionomer restorative with true esthetics



50 capsules
Code: 17-504

\$138.00

Restauration en verre ionomère avec vrai esthétique

RESTORATIVES (COMPOSITE)

RESTAURATIONS (COMPOSITE)

HERCULITE XRV™

Microhybrid Dental Composite



Composite dentaire microhybride

20 x 0.25gm. compules
Code: 17-316

5gm. syringe - seringue
Code: 17-317

\$ 59.95

\$ 59.95



POINT 4™

Optimized Particle Composite System



Système de Composite en particule optimisé

20 x 0.2g. Compules
Code: 17-318

\$ 66.29

TETRIC EVOCERAM®

Light-curing, universal nanohybrid composite



Composite universel nanohybride photopolymérisable

20 x 0.25gm. compules
Code: 17-321

4gm. syringe - seringue
Code: 17-322

\$107.95

\$ 79.95



HELIOMOLAR®

Light-Cured Restorative Composite with medium-viscosity



Composite photopolymérisable avec viscosité moyenne

3gm. syringe - seringue
Code: 17-320

\$ 79.95

TETRIC EVOFLOW®

Flowable composite



Composite fluide

2gm. syringe - seringue
Code: 17-413

\$ 47.19

HELIOMOLAR® FLOW

Flowable microfilled composite



Composite fluide microchargé

1.6gm. syringe - seringue
Code: 17-412

\$ 47.19

GRANDIO® SO

Universal nanohybrid composite



Composite universel nanohybride

16 x 0.25gm. compules
Code: 17-325

4gm. syringe - seringue
Code: 17-324

\$123.95

\$123.95

Danville STARFLOW™

Light-cure, highly filled flowable composite



Composite photopolymérisable fluide hautement chargé

5gm. syringe - seringue
Code: 17-403

\$ 55.06

RESTORATIVES (COMPOSITE)

RESTAURATIONS (COMPOSITE)

FILTEK™ FLOWABLE

Light-cured flowable nanocomposite



Nano-composite fluide photopolymérisable

2 x 2gm. syringe - seringue
Code: 17-401

\$ 76.97



FILTEK™ BULK FILL FLOWABLE

Posterior flowable composite



Composite fluide postérieur

2 x 2gm. syringe - seringue
Code: 17-402

\$103.93

DYRACT® FLOW

Universal compomer flowable



restauration compomère universel fluide

2 x 1.8gm. syringe - seringue
Code: 17-404

\$110.11



Dentsply Sirona

SUREFIL® SDR® FLOW

Composite base used for posterior restorations



Une base composite utilisée pour les restaurations postérieures

15 x 0.25gm. compules
Code: 17-410

\$107.87

2 X 1gm. syringe - seringue
Code: 17-411

\$ 65.16

REVOLUTION™ FORMULA 2

Flowable, light-cure, hybrid resin



Résine hybride restauratrice photopolymérisable et fluide

4 x 1gm. syringe - seringue
Code: 17-406

\$ 99.95



GC America Inc.

G-AENIAL™ UNIVERSAL FLO

Nano-hybrid, light-cured flowable composite



Composite fluide photopolymérisable nanohybride

3.4gm. syringe - seringue
Code: 17-405

\$ 94.38

GC FUJI II LC®

Glass Ionomer light-cured resin-reinforced restorative



Verre ionomère restauratif renforcé de résine et photopolymérisable

48 capsules
Code: 17-501

\$279.95

15gm, Powder - poudre
6,8ml Liq.
Code: 17-502

\$259.95

GC America Inc.

EQUIA® FORTE FIL

Posterior restorative system auto-adhesive



Système de restauration postérieure auto-adhésif

48 capsules
Code: 17-503

\$279.99

WHITENING

BLANCHIMENT

POLADAY / POLANIGHT

PolaDay: 7.5% / 9%
Hydrogen peroxide

PolaNight: 16% - 22%
Carbamide peroxide



PolaDay: 7.5% / 9%
Peroxide d'hydrogene

PolaNight: 16% - 22%
Peroxide de carbamide

50 syringes - seringues
Code: 18-101

\$206.74



POLANIGHT MINI

PolaNight:
10% - 16% - 22%
Carbamide peroxide



PolaNight:
10% 16% - 22%
Peroxide de carbamide

4 x 1.3gm. syringes - seringues
Code: 18-102

\$ 26.97

KOOL-DAM

Heatless liquid dam and
block out resin



PULPDENT®
Dental Innovation Since 1947

Digue liquide sans
chauffage et résine de
blocage

2 x 3ml. syringes - seringues
Code: 18-104

\$ 74.00



SOFT EVA 0.04"

Resin sheets 0.04" for
whitening trays



Feuilles en résine 0.04"
pour fabriquer les
goutiers de
blanchiment

25/bos - boîte
Code: 18-105

\$ 32.02



KULZER
MITSUI CHEMICALS GROUP

VENUS WHITE PRO

Venus White Pro:

16%, 22% and 35% carbamide peroxide
Peroxide de carbamide 16%, 22% et 35%

Venus Max:

35% Hydrogen peroxide
Peroxide d'hydrogene 35%

40005166	Patient Kit 16%	\$ 54.95
40005167	Patient Kit 22%	\$ 54.95
40005460	Patient Kit 35%	\$ 54.95
40005211	Max In-Office Whitening Kit	\$ 79.95
40005462	Refill Kit 35%	\$ 32.95
40005165	Venus Refill Kit 22%	\$ 32.95
40005164	Venus White Pro Refill Kit 16%	\$ 32.95
40005464	Venus White Pro Bulk Kit 22% 50/Pk	\$253.95
40005465	Venus White Pro Bulk Kit 35% 50/Pk	\$253.95
40005210	Ultra Pre-filled Trays 11.2% HP	\$ 47.95
66087539	Venus White Ultra+ Pre-filled Trays 15% HP	\$ 53.95
66087538	Venus White Ultra	\$ 47.95
40005202	Gingival Barrier 4 x 1.2ml Syringe	\$ 69.95
66051761	Venus White Touch-Up Brush 1.9ml	\$ 19.95



DENTIX - FOMA - FILMS



Class D
Medium speed



Classe D
Vitesse moyenne

150/pack - paquet

Adult
Film # 2
Code: 19-101

Child / Enfant
Film #0
Code: 19-102

\$ 58.00

\$ 54.00

**UNIVERSAL FILM MOUNT
CADRE FILM UNIVERSEL**



Perforated and
has a white strip for
film records

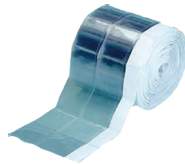

Perforé avec une bande
blanche pour
l'enregistrement

1000/roll - rouleau
Code: 19-109

\$ 38.76



**DENTAL FILM
FILM DENTAIRE**



Code	Film	Price / Prix
19-103	DF-58	\$ 76.40
19-104	DF-54	\$ 71.91
19-105	DF-56	\$ 76.40
19-106	IP-21	\$ 88.76
19-107	TMG5	\$129.00
19-108	TMG15	\$143.82

**BITEWING TABS
LANGUETTES INTERPROXIMALES**



**BITEWING LOOPS
LANGUETTES LOOP**

Holds dental film in
position



Maintenir
correctement les films
en place

550/box - Boîte
Code: 19-127

\$ 14.04



Adult #2
500/box - Boîte
Code: 19-125

Child #0
500/box - Boîte
Code: 19-126

\$ 13.50

\$ 13.50

**FRAMED FILM MOUNT
PORTE-FILM ENCADRÉ**

ID-8H
size #2H
8 windows

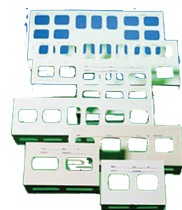

ID-8H
Taille #2H
8 fenetres

100/box - Boîte
Code: 19-129

\$ 76.97

**FILM MOUNT SHEETS
FEUILLE DE CADRE FILM**

4" X 10"



4" X 10"

100/box - Boîte
Code: 19-130

\$ 24.72

**FILM / PSP HOLDERS
PORTES FILMS / PSP**

Ring / Anneau:
Code: 19-122

XR-0934: BiteWing (red)
BiteWing rouge

XR-0865: Anterior (Blue)
Antérieur (bleu)

XR-0860: Posterior (Yellow)
Postérieur (jaune)

\$ 8.43

Arm / Manche:
Code: 19-121

XR-0927: Bitewing
Bitewing

XR-0857: Anterior
Antérieur

XR-0858: Posterior
Postérieur

\$ 21.35

Plasdent
Plastic Dental Solutions

Bite Blocks
Code: 19-123

XR-0933: Bitewing
(Red,H0/1)

XR-0929: Bitewing
(Red,H2)

XR-0922: Bitewing
(Red,V1)

XR-0941: Bitewing
(Red,V2)

XR-0861: Anterior
(Blue)

XR-0862: Posterior
(Yellow)

\$1.95Ea/ch

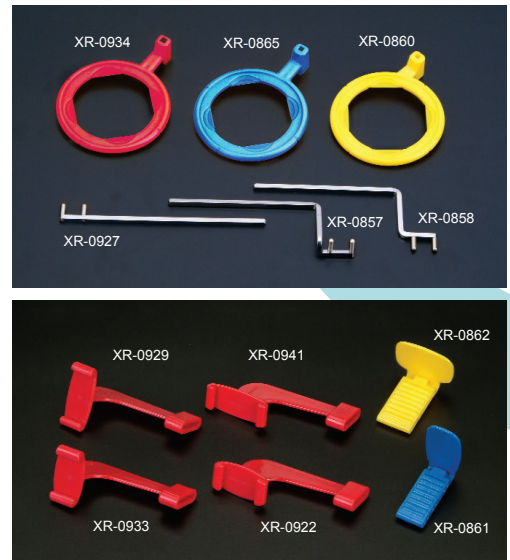

ClikRay

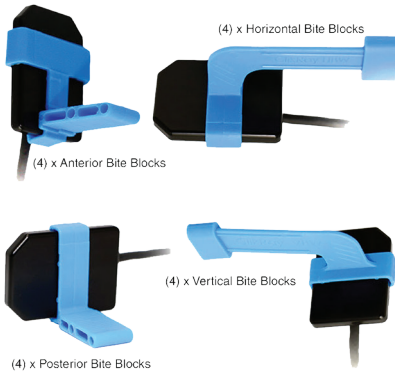

Universal Systems for all Digital Sensors

ClikStik™ CCD Complete (Ring, Rod, ClikStik and 16 assorted Biteblocks) Item #001-282				
Posterior Biteblocks	Size 1 Yellow	#001-305	Size 2 Blue	#001-343
Anterior Biteblocks	Size 1 Yellow	#001-299	Size 2 Blue	#001-336
Horizontal BW	Size 1 Yellow	#001-329	Size 2 Blue	#001-367
Vertical BW	Size 1 Yellow	#001-312	Size 2 Blue	#001-350

D-SERIES Biteblocks for Dexis & Gendex Size 1

Posterior	Size 1 Lime	#008-308
Anterior	Size 1 Aqua	#008-292
Horizontal BW	Size 1 Dark Orange	#008-315
Vertical BW	Size 1 Dark Orange	#008-322

D-SERIES Biteblocks for Dexis & Gendex Size 2

Posterior	Size 1.5 Lime	#001-978
Anterior	Size 1.5 Aqua	#001-961
Horizontal BW	Size 1.5 Dark Orange	#001-985
Vertical BW	Size 1.5 Dark Orange	#001-992

Systems for X-Ray Film & PSP Plates

ClikStik™ CCF Complete (Ring, Rod, ClikStik and 16 assorted Biteblocks) #001-275				
Posterior Biteblocks	Yellow	#001-381		
Anterior Biteblocks	Blue	#001-374		
Horizontal BW	Size 1 Orange	#001-398	Size 2 Orange	#001-411
Vertical BW	Size 1 Orange	#001-404	Size 2 Orange	#001-428

Z-SERIES Biteblocks for Carestream RVG and Schick Elite/33 (blue-white)

Posterior Biteblocks	Size 1 Rose	#001-909	Size 2 Purple	#001-862
Anterior Biteblocks	Size 1 Rose	#001-916	Size 2 Purple	#001-879
Horizontal BW	Size 1 Rose	#001-893	Size 2 Purple	#001-855
Vertical BW	Size 1 Rose	#001-886	Size 2 Purple	#001-848

X-SERIES Biteblocks for Thinner Sensors such as Apex, Dentimax, original black Schick, SOTA

Posterior Biteblocks	Size 1 Yellow	#001-534	Size 2 Blue	#001-572
Anterior Biteblocks	Size 1 Yellow	#001-527	Size 2 Blue	#001-565
Horizontal BW	Size 1 Yellow	#001-541	Size 2 Blue	#001-589
Vertical BW	Size 1 Yellow	#001-558	Size 2 Blue	#001-596

ClikStik™ system (Ring, Rod and ClikStik)	#001-220
ClikRay™ Dexis™ system (D+DPV+G)	#001-510
ClipRay™ system (Ring, Rod and ClipRay)	#001-435
ShaRing™ + Litening Rods™ Kit	#001-701
VersaRay™ System - 2 Pak	#001-039
HandiBar™ System 2 Pak	#008-247

XL-SERIES Biteblocks for Acteon, XDR

Posterior Biteblocks	Size 1 Yellow	#008-018	Size 2 Yellow	#008-056
Anterior Biteblocks	Size 1 Navy	#008-001	Size 2 Navy	#008-049
Horizontal BW	Size 1 Dark Orange	#008-025	Size 2 Dark Orange	#008-063
Vertical BW	Size 1 Dark Orange	#008-032	Size 2 Dark Orange	#008-070

V-SERIES Biteblocks for GoodDrs and VaTech

Posterior Biteblocks	Size 1 Coral	#008-216	Size 1.5 Sage	#008-179	Size 2 White	#008-131
Anterior Biteblocks	Size 1 Coral	#008-209	Size 1.5 Sage	#008-162	Size 2 White	#008-124
Horizontal BW	Size 1 Coral	#008-230	Size 1.5 Sage	#008-193	Size 2 White	#008-155
Vertical BW	Size 1 Coral	#008-223	Size 1.5 Sage	#008-186	Size 2 White	#008-148

ClikRay™ Sensor Covers

ClikRay™ Sensor Covers			
Size 1	#001-138	Fits most Size 1 sensors	
Size 1+2	#001-145	Fits Carestream Size 1 and thinner Size 2 sensors	
Size 2	#001-152	Fits ALL sensors including Dexis	
Universal	#001-442	Fits ALL sensors: biodegradable green	
I/O Sleeves for DexCam 3			#001-763

**FILMS / PSP
BITE BLOCK**

6/pack - paquet

\$19.95

**SENSORS
BITE BLOCK**

3/pack - paquet

\$29.95

**XIOS SENSOR HOLDERS
LANGUETTES DE CAPTEURS XIOS**



100/pack - paquet
Code: 19-124

\$83.15

MICROCOPY ORIGINAL FLAPS®,

Soft plastic foam with a self-adhesive side



Mousse plastique avec face auto-adhésive

500/box - boîte
Code: 19-120

\$60.67

ScanX® PHOSPHOR PLATE
PLAQUES PHOSPHORIQUES ScanX®



PERI-PRO

Stockage phosphorus plates sizes: 0 or 2



Plaques de stockage phosphoriques taille 0 ou 2

Developer & Fixer for manual machine 3 quart of each



Rélevateur et fixateur pour machine manuelle 3 quart de chaque

Size 0
2/pack - paquet
Code: 19-118

Size 2
4/pack - paquet
Code: 19-119

Code: 19-139

\$166.29

\$359.55

\$ 89.00

SAFE 'N' SURE DELUXE™ PSP



FORMULA 2000 PLUS

Barrier envelopes for phosphor plates. Soft vinyl with transparent side



Enveloppes de barrière pour les plaques phosphoriques. En vinyl avec un côté transparent

Tank and Transport cleaner



Nettoyant pour le réservoir et le transport

300/box - boîte

2 x 1L
Code: 19-137

\$ 93.95

\$106.18

PANORAMIC BITE BLOCKS



SENSOR SLEEVES
COUVRES CAPTEURS

7000
Fits Midwest and Ritter Panorol and J. Morita Versaview
7010
Fits Siemens OP10 and Instrumentarium
7030
Fits Phillips, Den-Tal-Ez Panolite and Soredex
7040
Fits GE Panolipse and Gendex
7060
Fits Planmeca
7080
Fits FBelmont Autopan FiAD
7090
Fits Belmont X-Caliber
7095
Fits Panoramic Corporation

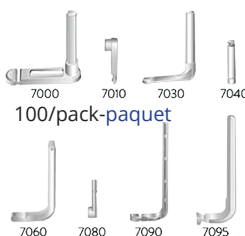

100/pack-paquet

Code: 19-131

\$ 58.43

#7798
Size#1 - 13/8" x 8"

#7799
Size#2 - 15/8" x 8"



#7798
Taille#1 - 13/8" x 8"

#7799
Taille#2 - 15/8" x 8"

500/Box - Boîte

\$ 16.00

DIGITAL X-RAY SLEEVES
COUVRE X-RAY DIGITALE



FIXERS & DEVELOPERS
FIXATEURS & RÉLEVATEURS

Size #1
8"x 1.625" -
20.32cm x 4.12cm
Size #2
8"x 1.375"
20.32cm x 3.49cm



Taille #1
8"x 1.625" -
20.32cm x 4.12cm
Taille #2
8"x 1.375"
20.32cm x 3.49cm

500/Box - Boîte

\$ 16.00



19-132 BM 2000
2 X DEVELOPER & 2 X FIXER 4 L. EACH

\$57.95

19-134 BM 3000
PRO DEVELOPER & FIXER 6 x 1 LITRE

\$48.00

19-138 BM F2000
DUAL USE TANK & TRANSPORT CLEANER 1 KIT

\$72.00

PRAXIS™ MINI-TWIN
Roth Prescription



Circular Trays

	Hooks	QTY / Trays	Slot .018	Slot .022
All Hooks	x	1	265-901	265-902
Cuspid Hooks	x	1		265-904
All Hooks	x	5	265-911	265-912
All Hooks	x	10	265-921	265-922

Redi-Pak™

20 brackets per pack / paquet

\$ 54.00

Hooks **GOB**

Slot	Slot
.018	.022

	Hooks	GOB	Slot .018	Slot .022
All Hooks	x		265-933	265-934
Cuspid Hooks	x		265-937	265-938
No Hooks			265-941	265-942
All Hooks GOB	x	x	265-945	265-946
Cuspid Hooks GOB	x	x	265-949	265-950
Cuspid Hooks 7x7	x			265-956
6x6				265-957
Cuspid Hooks 6x6	x			265-959
Upper Cuspid Hooks	x			265-960

PRAXIS™ MINI-TWIN
Roth Prescription

\$2.65 Ea / ch.

Upper / Maxillary

	Torque	Angle	Anti Rotate	Hook	GOB	L/R	Slot .018		Slot .022	
							10 Pack	Each	10 Pack	Each
Central	+12°	+5°				R	265-201	265-201B	265-301	265-301B
						L	265-202	265-202B	265-302	265-302B
Lateral	+8°	+9°				R	265-211	265-211B	265-311	265-311B
						L	265-212	265-212B	265-312	265-312B
Cuspid	-2°	+13°	MAR 4°	x		R	265-225	265-225B	265-325	265-325B
						L	265-226	265-226B	265-326	265-326B
						R	265-227	265-227B	265-327	265-327B
						L	265-228	265-228B	265-328	265-328B
Bicuspid	-7°	0°	DAR 2°	x		R	265-031	265-031B	265-131	265-131B
						L	265-032	265-032B	265-132	265-132B
						R	265-033	265-033B	265-133	265-133B
						L	265-034	265-034B	265-134	265-134B
				x	x	R	265-035	265-035B	265-135	265-135B
						L	265-036	265-036B	265-136	265-136B
						R	265-037	265-037B	265-137	265-137B
						L	265-038	265-038B	265-138	265-138B



Buy / Achetez 20 Redi-Pak
Get / OBTENEZ
A / UN
Consultation model
FREE !! / GRATUIT!!

Lower / Mandibular

	Torque	Angle	Anti Rotate	Hook	GOB	L/R	Slot .018		Slot .022	
							10 Pack	Each	10 Pack	Each
Anterior	-1°	0°					265-045	265-045B	265-145	265-145B
Cuspid	-11°	+7°	MAR 2°	x		R	265-051	265-051B	265-151	265-151B
						L	265-052	265-052B	265-152	265-152B
						R	265-053	265-053B	265-153	265-153B
						L	265-054	265-054B	265-154	265-154B
1st Bicuspid	-17°	0°	MAR 4°	x		R	265-061	265-061B	265-161	265-161
						L	265-062	265-062B	265-162	265-162B
						R	265-063	265-063B	265-163	265-163B
						L	265-064	265-064B	265-164	265-164B
				x	x	R	265-065	265-065B	265-165	265-165B
						L	265-066	265-066B	265-166	265-166B
						R	265-067	265-067B	265-167	265-167B
						L	265-068	265-068B	265-168	265-168B
2nd Bicuspid	-22°	0°	MAR 4°	x		R	265-071	265-071B	265-171	265-171B
						L	265-072	265-072B	265-172	265-172B
						R	265-073	265-073B	265-173	265-173B
						L	265-074	265-074B	265-174	265-174B
				x	x	R	265-075	265-075B	265-175	265-175B
						L	265-076	265-076B	265-176	265-176B
						R	265-077	265-077B	265-177	265-177B
						L	265-078	265-078B	265-178	265-178B



Praxis Roth Consultation Model
915-125

\$285.00

PRAXIS™ MINI-TWIN
MBT Prescription

Circular Trays

	Hooks	QTY / Trays	Slot .018	Slot .022
All Hooks	x	1	268-901	268-902
All Hooks	x	10		268-922

PRAXIS™ MINI-TWIN
MBT Prescription
Upper / Maxillary

\$2.65 Ea / ch.

	Torque	Angle	Hook	GOB	L/R	Slot .018		Slot .022	
						10 Pack	Each	10 Pack	Each
Central	+17°	+4°			R	268-201	268-201B	268-301	268-301B
					L	268-202	268-202B	268-302	268-302B
Lateral	+10°	+8°	x		R	268-211	268-211B	268-311	268-311B
					L	268-212	268-212B	268-312	268-312B
					R		268-213B		
					L		268-214B		
Cuspid	0°	+8°	x		R	268-221	268-221B	268-321	268-321B
					L	268-222	268-222B	268-322	268-322B
	-7°	+8°			R	268-223	268-223B	268-323	268-323B
					L	268-224	268-224B	268-324	268-324B
Bicuspid	-7°	0°	x		R	268-031	268-031B	268-131	268-131B
					L	268-032	268-032B	268-132	268-132B
						268-033	268-033B	268-133	268-133B
			x	x	R			268-135	268-135B
					L			268-136	268-136B
								268-137	268-137B

Lower / Mandibular

	Torque	Angle	Hook	GOB	L/R	Slot .018		Slot .022	
						10 Pack	Each	10 Pack	Each
Anterior	-6°	0°	x		R	268-045	268-045B	268-145	268-145B
					L		268-046B		268-047B
Cuspid	0°	+3°	x		R	268-051	268-051B	268-151	268-151B
					L	268-052	268-052B	268-152	268-152B
	-6°	+3°			R	268-053	268-053B	268-153	268-153B
					L	268-054	268-054B	268-154	268-154B
1st Bicuspid	-12°	+2°	x		R	268-061	268-061B	268-161	268-161B
					L	268-062	268-062B	268-162	268-162B
						268-063	268-063B	268-163	268-163B
			x	x	R			268-165	268-165B
					L			268-166	268-166B
								268-167B	268-167B
2nd Bicuspid	-17°	+2°	x		R	268-071	268-071B	268-171	268-171B
					L	268-072	268-072B	268-172	268-172B
						268-073	268-073B	268-173	268-173B
			x	x	R			268-175	268-175B
					L			268-176	268-176B
								268-177	268-177B
		x			268-078B	268-178	268-178B		

Redi-Pak™

20 brackets per pack / paquet

\$48.00

Hooks GOB

Slot .018

Slot .022

	Hooks	GOB	Slot .018	Slot .022
All Hooks	x		268-931	268-932
Cuspid Hooks	x		268-933	268-934
No Hooks			268-935	268-936
All Hooks GOB	x	x		268-938
Cuspid Hooks GOB	x	x		268-940
GOB		x	268-941	268-942
SFP All Hooks w/ BT 6x6	x			268-944
Extraction Hooks	x		268-945	268-946
No Hooks 2 Bicuspids 6x6				268-947
Hooks w/ Single N/C BT 6x6	x			268-949
SFP All Hooks	x		268-951	268-952
SFP			268-953	268-954
SFP Cuspid Hooks	x		268-955	268-956
SFP Cuspid Hooks 7x7	x			268-960
Cuspid Hooks 6x6	x			268-962
Cuspid Hooks 7x7	x			268-964
No Hooks 6x6			268-990	

Buy / Achetez 20 Redi-Pak
Get / OBTENEZ
A / UN
Consultation model
FREE !! / GRATUIT!!



Praxis MBT Consultation Model
915-132

\$285.00



VELOCITY™ PASSIVE SLB
Roth Prescription

Redi-Pak™

20 brackets
per
pack / paquet

\$148.00

Hooks

 Slot .018	 Slot .022		
All Hooks	x	21RK-345-18	21RK-345-22

Upper / Maxillary

\$7.60 Ea / ch.

	Torque	Angle	Hook	L/R	Slot .018 Each	Slot .022 Each
Central	+12°	+5°		R	21R-18R	21R-12R
				L	21R-18L	21R-12L
Lateral	+8°	+9°		R	21R-28R	21R-22R
				L	21R-28L	21R-22L
Cuspid	-2°	+11°	x	R	21R-38R	21R-32R
				L	21R-38L	21R-32L
				R	21R-38RN	21R-32RN
				L	21R-38LN	21R-32LN
1st Bicuspid	-7°	0°	x	R	21R-48R	21R-42R
				L	21R-48L	21R-42L
				R	21R-48RN	21R-42RN
				L	21R-48LN	21R-42LN
2nd Bicuspid	-7°	0°	x	R	21R-98R	21R-92R
				L	21R-98L	21R-92L
				R	21R-98RN	21R-92RN
				L	21R-98LN	21R-92LN



Lower / Mandibular

	Torque	Angle	Hook	L/R	Slot .018 Each	Slot .022 Each
Anterior	-1°	0°			21R-58U	21R-52U
Cuspid	-11°	+7°	x	R	21R-68R	21R-62R
				L	21R-68L	21R-62L
				R	21R-68RN	21R-62RN
				L	21R-68LN	21R-62LN
1st Bicuspid	-17°	0°	x	R	21R-78R	21R-72R
				L	21R-78L	21R-72L
				R	21R-78RN	21R-72RN
				L	21R-78LN	21R-72LN
2nd Bicuspid	-17°	+2°	x	R	21R-88R	21R-82R
				L	21R-88L	21R-82L
				R	21R-88RN	21R-82RN
				L	21R-88LN	21R-82LN

Buy / Achetez 20 Redi-Pak
Get / OBTENEZ
A / UN
Consultation model
FREE !! / GRATUIT!!



Velocity Passive SLB
Consultation Model
915-21

\$360.00

VELOCITY™ PASSIVE SLB
MBT Prescription

Redi-Pak™

20 brackets
per
pack / paquet

\$148.00

Slot .018	Slot .022
--------------	--------------

Hooks

All Hooks

x 21MK-345-18 21-MK-345-22

Upper / Maxillary

\$7.60 Ea / ch.

	Torque	Angle	Hook	L/R	Slot .018 Each	Slot .022 Each
Central	+17°	+4°		R	21M-18R	21M-12R
				L	21M-18L	21M-12L
Lateral	+10°	+8°		R	21M-28R	21M-22R
				L	21M-28L	21M-22L
Cuspid	-7°	+8°	x	R	21M-38R	21M-32R
				L	21M-38L	21M-32L
				R	21M-38RN	21M-32RN
				L	21M-38LN	21M-32LN
1st Bicuspid	-7°	0°	x	R	21M-48R	21M-42R
				L	21M-48L	21M-42L
				R	21M-48RN	21M-42RN
				L	21M-48LN	21M-42LN
2nd Bicuspid	-7°	0°	x	R	21M-98R	21M-92R
				L	21M-98L	21M-92L
				R	21M-98RN	21M-92RN
				L	21M-98LN	21M-92LN



Lower / Mandibular

	Torque	Angle	Hook	L/R	Slot .018 Each	Slot .022 Each
Anterior	-6°	0°			21M-58U	21M-52U
Cuspid	-6°	+3°	x	R	21M-68R	21M-62R
				L	21M-68L	21M-62L
				R	21M-68RN	21M-62RN
				L	21M-68LN	21M-62LN
1st Bicuspid	-12°	+2°	x	R	21M-78R	21M-72R
				L	21M-78L	21M-72L
				R	21M-78RN	21M-72RN
				L	21M-78LN	21M-72LN
2nd Bicuspid	-17°	+2°	x	R	21M-88R	21M-82R
				L	21M-88L	21M-82L
				R	21M-88RN	21M-82RN
				L	21M-88LN	21M-82LN

Buy / Achetez 20 Redi-Pak
Get / Obtenez
A / UN
Consultation model
FREE !! / GRATUIT!!

VELOCITY™ ACTIVE SLB
Roth Prescription

Redi-Pak™

20 brackets
per
pack / paquet

\$168.00

Hooks



Slot
.018



Slot
.022

All Hooks

x

23RK-345-18

23RK345-22

Upper / Maxillary

\$8.90 Ea / ch.

	Torque	Angle	Hook	L/R	Slot .018 Each	Slot .022 Each
Central	+12°	+5°		R	23R-18R	23R-12R
				L	23R-18L	23R-12L
Lateral	+8°	+9°		R	23R-28R	23R-22R
				L	23R-28L	23R-22L
Cuspid	-2°	+11°	x	R	23R-38R	23R-32R
				L	23R-38L	23R-32L
1st Bicuspid	-7°	0°	x	R	23R-48R	23R-42R
				L	23R-48L	23R-42L
				R	23R-48RN	23R-42RN
				L	23R-48LN	23R-42LN
2nd Bicuspid	-7°	0°	x	R	23R-98R	23R-92R
				L	23R-98L	23R-92L
				R	23R-98RN	23R-92RN
				L	23R-98LN	23R-92LN

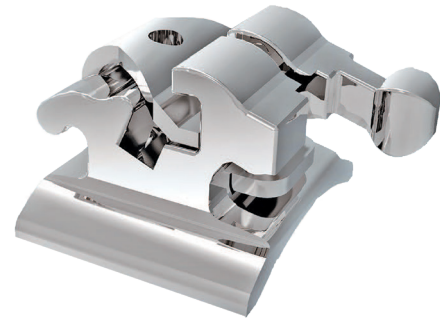

Buy / Achetez 20 Redi-Pak
Get / OBTENEZ
A / UN
Consultation model
FREE !! / GRATUIT!!

Lower / Mandibular

	Torque	Angle	Hook	L/R	Slot .018 Each	Slot .022 Each
Anterior	-1°	0°			23R-58U	23R-52U
Cuspid	-11°	+7°	x	R	23R-68R	23R-62R
				L	23R-68L	23R-62L
1st Bicuspid	-17°	0°	x	R	23R-78R	23R-72R
				L	23R-78L	23R-72L
				R	23R-78RN	23R-72RN
				L	23R-78LN	23R-72LN
2nd Bicuspid	-17°	+2°	x	R	23R-88R	23R-82R
				L	23R-88L	23R-82L
				R	23R-88RN	23R-82RN
				L	23R-88LN	23R-82LN



Velocity Active SLB
Consultation Model
915-23

\$360.00

VELOCITY™ ACTIVE SLB
MBT Prescription

Redi-Pak™

20 brackets
per
pack / paquet

\$168.00

Hooks



All Hooks x 23MK-345-18 23MK-345-22

Upper / Maxillary

\$8.90 Ea / ch.

	Torque	Angle	Hook	L/R	Slot .018 Each	Slot .022 Each
Central	+17°	+4°		R	23M-18R	23M-12R
				L	23M-18L	23M-12L
Lateral	+10°	+8°		R	23M-28R	23M-22R
				L	23M-28L	23M-22L
Cuspid	-7°	+8°	x	R	23M-38R	23M-32R
				L	23M-38L	23M-32L
1st Bicuspid	-7°	0°	x	R	23M-48R	23M-42R
				L	23M-48L	23M-42L
				R	23M-48RN	23M-42RN
				L	23M-48LN	23M-42LN
2nd Bicuspid	-7°	0°	x	R	23M-98R	23M-92R
				L	23M-98L	23M-92L
				R	23M-98RN	23M-92RN
				L	23M-98LN	23M-92LN

Lower / Mandibular

	Torque	Angle	Hook	L/R	Slot .018 Each	Slot .022 Each
Anterior	-6°	0°			23M-58U	23M-52U
Cuspid	-6°	+3°	x	R	23M-68R	23M-62R
				L	23M-68L	23M-62L
1st Bicuspid	-12°	+2°	x	R	23M-78R	23M-72R
				L	23M-78L	23M-72L
				R	23M-78RN	23M-72RN
				L	23M-78LN	23M-72LN
2nd Bicuspid	-17°	+2°	x	R	23M-88R	23M-82R
				L	23M-88L	23M-82L
				R	23M-88RN	23M-82RN
				L	23M-88LN	23M-82LN

Buy / Achetez 20 Redi-Pak
Get / OBTENEZ
A / UN
Consultation model
FREE !! / GRATUIT!!

VELOCITY™ ACTIVE SLB CERAMIC

Roth Prescription

Redi-Pak™

20 brackets per pack / paquet

\$220.00

Hooks

Slot .018*	Slot .022
---------------	--------------

All Hooks	x	24RK-345-18	24RK-345-22
-----------	---	-------------	-------------

Upper / Maxillary

\$11.45 Ea / ch.

	Torque	Angle	Hook	L/R	Slot .018* Each	Slot .022 Each
Central	+12°	+5°		R	24R-18R	24R-12R
				L	24R-18L	24R-12L
Lateral	+8°	+9°		R	24R-28R	24R-22R
				L	24R-28L	24R-22L
Cuspid	0°	+11°	x	R	24R-38R	24R-32R
				L	24R-38L	24R-32L
Bicuspid	-7°	0°	x	R	24R-48R	24R-42R
				L	24R-48L	24R-42L



Lower / Mandibular

	Torque	Angle	Hook	L/R	Slot .018* Each	Slot .022 Each
Anterior	0°	0°			24R-58U	24R-52U
Cuspid	-11°	+7°	x	R	24R-68R	24R-62R
				L	24R-68L	24R-62L

Lower Bicuspids are Active SLB Metal

*.018 Slot available in 2019

1st Bicuspid	-17°	0°	x	R	23R-78R	23R-72R
				L	23R-78L	23R-72L
				R	23R-78RN	23R-72RN
				L	23R-78LN	23R-72LN
2nd Bicuspid	-17°	+2°	x	R	23R-88R	23R-82R
				L	23R-88L	23R-82L
				R	23R-88RN	23R-82RN
				L	23R-88LN	23R-82LN

Buy / Achetez 20 Redi-Pak
Get / OBTENEZ
A / UN
Consultation model
FREE !! / GRATUIT!!



Velocity Active SLB Ceramic
Consultation Model

915-24

\$360.00

**VELOCITY™ ACTIVE
SLB CERAMIC
MBT Prescription**

Redi-Pak™

20 brackets
per
pack / paquet

\$220.00

Hooks



Slot

.018*



Slot

.022

All Hooks

x

24MK-345-18

24MK-345-22

Upper / Maxillary

\$11.45 Ea / ch.

	Torque	Angle	Hook	L/R	Slot .018* Each	Slot .022 Each
Central	+17°	+4°		R	24M-18R	24M-12R
				L	24M-18L	24M-12L
Lateral	+10°	+8°		R	24M-28R	24M-22R
				L	24M-28L	24M-22L
Cuspid	-7°	+8°	x	R	24M-38R	24M-32R
				L	24M-38L	24M-32L
	0°	+8°		R	24M-38R0	24M-32R0
				L	24M-38L0	24M-32L0
Bicuspid	-7°	0°	x	R	24M-48R	24M-42R
				L	24M-48L	24M-42L
						24M-48N

Lower / Mandibular

	Torque	Angle	Hook	L/R	Slot .018* Each	Slot .022 Each
Anterior	-6°	0°			24M-58U	24M-52U
Cuspid	-6°	+3°	x	R	24M-68R	24M-62R
				L	24M-68L	24M-62L
	0°	+3°		R	24M-68R0	24M-62R0
				L	24M-68L0	24M-62L0

Lower Bicuspids are Active SLB Metal

*.018 Slot available in 2019

1st Bicuspid	-12°	+2°	x	R	23M-78R	23M-72R
				L	23M-78L	23M-72L
				R	23M-78RN	23M-72RN
				L	23M-78LN	23M-72LN
2nd Bicuspid	-17°	+2°	x	R	23M-88R	23M-82R
				L	23M-88L	23M-82L
				R	23M-88RN	23M-82RN
				L	23M-88LN	23M-82LN

**Buy / Achetez 20 Redi-Pak
Get / OBTENEZ
A / UN
Consultation model
FREE !! / GRATUIT!!**

**OPTYC™ CERAMIC
Roth Prescription**

Redi-Pak™ 20 brackets per pack / paquet

\$ 98.00

	Hooks	Slot .018	Slot .022
All Hooks	x	246-941	246-942
Hooks on Cuspids	x	246-945	246-946

Upper / Maxillary

\$ 5.45 Ea / ch.

	Torque	Angle	Hook	L/R	Slot .018 Each	Slot .022 Each
Central	+17°	+4°		R	246-401	246-501
				L	246-402	246-502
Lateral	+10°	+8°		R	246-411	246-511
				L	246-412	246-512
Cuspid	0	+8°	x	R	246-421	246-521
				L	246-422	246-522
Bicuspid	-7°	0			246-433	246-533



**Buy / Achetez 20 Redi-Pak
Get / OBTENEZ
A / UN
Consultation model
FREE !! / GRATUIT!!**

Lower / Mandibular

	Torque	Angle	Hook	L/R	Slot .018 Each	Slot .022 Each
Anterior	-6°	0			246-441	246-541
Cuspid	0	+3°	x	R	246-451	246-551
				L	246-452	246-552
1st Bicuspid	-12°	0			246-463	246-563
2nd Bicuspid	-17°	0			246-473	246-573



**Optyc Consultation Model
915-138**

\$360.00

OPTYC™ CERAMIC MBT Prescription

Redi-Pak™ 20 brackets per pack / paquet

\$ 98.00

Hooks

Slot	Slot
.018	.022
All Hooks	x 231-941 231-942
Hooks on Cuspids	x 231-947 231-948

Upper / Maxillary

\$ 5.45 Ea / ch.

	Torque	Angle	Hook	L/R	Slot .018 Each	Slot .022 Each
Central	+17°	+4°		R	231-401	231-501
				L	231-402	231-502
Lateral	+10°	+8°		R	231-411	231-511
				L	231-412	231-512
Cuspid	0	+8°	x	R	231-421	231-521
				L	231-422	231-522
Bicuspid	-7°	0			231-433	231-533

**Buy / Achetez 20 Redi-Pak
Get / OBTENEZ
A / UN
Consultation model
FREE !! / GRATUIT!!**

Lower / Mandibular

	Torque	Angle	Hook	L/R	Slot .018 Each	Slot .022 Each
Anterior	-6°	0			231-441	231-541
Cuspid	0	+3°	x	R	231-451	231-551
				L	231-452	231-552
1st Bicuspid	-12°	0			231-463	231-563
2nd Bicuspid	-17°	0			231-473	231-573

PRAXIS™ SINGLE BUCCAL TUBES

\$ 4.51 Ea / ch.



PRAXIS™ BUCCAL TUBES

Upper / Maxillary

		Torque	Offset	L/R	.022 Each
Roth	1st Molar	-10°	8°	R	351-743
				L	351-744
	2nd Molar	-10°	8°	R	351-745
				L	351-746
MBT	1st Molar	-14°	10°	R	351-735
				L	351-736
	2nd Molar	-14°	10°	R	351-737
				L	351-738



Lower / Mandibular

		Torque	Offset	L/R	.022 Each
Roth	1st Molar	-25°	5°	R	351-747
				L	351-748
	2nd Molar	-25°	5°	R	351-749
				L	351-750
MBT	1st Molar	-20°	0°	R	351-739
				L	351-740
	2nd Molar	-20°	0°	R	351-741
				L	351-742



SINGLE DIRECT BOND BUCCAL TUBES

SINGLE NON-CONVERTIBLE

Upper / Maxillary

						.018 Each	.022 Each
	Torque	Offset	Hook	L/R			
	Roth	-10°	8°	x	R	351-633	351-733
					L	351-634	351-734
	MBT	-14°	8°	x	R	351-841	351-941
					L	351-842	351-942



Upper / Lower

						Each	Each
	Torque	Offset	Hook	L/R			
	Standard	0°	0°	x	UR/LL	351-603	351-703
					UL/LR	351-604	351-704
					UR/LL	351-613	351-713
					UL/LR	351-614	351-714
	Standard (No Hook)	0°	0°	ANY	ANY	351-001	351-101
					UR/LL	351-011	351-111
					UL/LR	351-012	351-112
					UL/LR	351-012	351-112



\$ 3.95

SINGLE NON-CONVERTIBLE

Lower / Mandibular



						.018 Each	.022 Each
	Torque	Offset	Hook	L/R			
	Roth	-25°	8°	x	R	351-653	351-753
					L	351-654	351-754
	MBT	-20°	8°	x	R	351-861	351-961
					L	351-862	351-962

Upper / Lower

						Each	Each
	Torque	Offset	Hook	L/R			
	Standard	0°	0°	x	UR/LL	351-603	351-703
					UL/LR	351-604	351-704
					UR/LL	351-613	351-713
					UL/LR	351-614	351-714
	Standard (No Hook)	0°	0°	ANY	ANY	351-001	351-101
					UR/LL	351-011	351-111
					UL/LR	351-012	351-112
					UL/LR	351-012	351-112

SINGLE CONVERTIBLE



Upper / Maxillary

						.018 Each	.022 Each
	Torque	Offset	L/R				
	Standard	0°	0°	R	336-802DL	336-902DL	
				L	336-801DL	336-901DL	
	Roth	-10°	8°	R	336-821DL	336-921DL	
				L	336-822DL	336-922DL	
	MBT	-14°	8°	R	336-843DL	336-943DL	
				L	336-844DL	336-944DL	

\$ 6.25

SINGLE CONVERTIBLE

Lower / Mandibular

						.018 Each	.022 Each
	Torque	Offset	L/R				
	Standard	0°	0°	R	336-801DL	336-901DL	
				L	336-802DL	336-902DL	
	Roth	-25°	5°	R	336-813DL	336-913DL	
				L	336-814DL	336-914DL	
	MBT	-20°	5°	R	336-863DL	336-963DL	
				L	336-864DL	336-964DL	

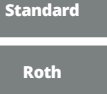

DOUBLE CONVERTIBLE

Upper / Maxillary

						.018 Each	.022 Each
	Torque	Offset	Aux	L/R			
	Standard	0°	8°	.018	R	342-804DL	342-904DL
					L	342-803DL	342-903DL
	Roth	-10°	8°	.018	R	342-821DL	342-921DL
					L	342-822DL	342-922DL

\$ 8.95

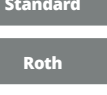
Lower / Mandibular



						.018 Each	.022 Each
	Torque	Offset	Aux	L/R			
	Standard	0°	8°	.018	R	342-803DL	342-903DL
					L	342-804DL	342-904DL
	Roth	-25°	8°	.018	R	342-813DL	342-913DL
					L	342-814DL	342-914DL
	MBT	-20°	8°	.018	R	342-861DL	342-961DL
					L	342-862DL	342-962DL

DOUBLE DIRECT BOND BUCCAL TUBES

DOUBLE NON-CONVERTIBLE RICKETTS W/ HOOK

\$ 7.95

Upper / Maxillary

						.018 Each
	Torque	Offset	L/R			
	w/ Aux Hook	0°	0°	R	346-605DL	
				L	346-606DL	
	Long Base w/ Ball Hook	0°	0°	R/L	342-011DL	
	Short Base w/ Ball Hook	0°	0°	R/L	342-011DS	

BAND KITS SIZE DISTRIBUTION CHART

MOLAR BANDS KITS

Supra & Supra Firm 1st Molar		Supra & Supra Firm 2nd Molar		Original Anatomical		1st & 2nd Bicuspid Upper		1st Bicuspid Lower		2nd Bicuspid Lower	
Size	Qty.	Size	Qty.	Size	Qty.	Size	Qty.	Size	Qty.	Size	Qty.
29.5	2	29.5	2	1	2	1	2	1	2	1	-
30	2	30	2	2	2	2	2	2	2	2	-
30.5	2	30.5	2	3	2	3	3	3	3	3	2
31	2	31	2	4	2	4	3	4	3	4	2
31.5	2	31.5	2	5	2	5	3	5	3	5	3
32	2	32	2	6	2	6	4	6	4	6	3
32.5	2	32.5	4	7	2	7	4	7	4	7	3
33	2	33	4	8	2	8	4	8	4	8	4
33.5	2	33.5	4	9	2	9	5	9	5	9	4
34	4	34	4	10	2	10	6	10	6	10	4
34.5	4	34.5	4	11	2	11	6	11	6	11	5
35	4	35	4	12	4	12	6	12	6	12	6
35.5	6	35.5	6	13	4	13	6	13	6	13	6
36	6	36	6	14	4	14	6	14	6	14	6
36.5	6	36.5	8	15	4	15	6	15	6	15	6
37	8	37	8	16	4	16	6	16	6	16	6
37.5	6	37.5	6	17	4	17	6	17	6	17	6
38	6	38	6	18	4	18	4	18	4	18	6
38.5	4	38.5	4	19	4	19	4	19	4	19	6
39	4	39	4	20	4	20	4	20	4	20	4
39.5	4	39.5	4	21	4	21	3	21	3	21	4
40	4	40	4	22	4	22	3	22	3	22	4
40.5	2	40.5	2	23	4	23	2	23	2	23	3
41	2	41	2	24	4	24	2	24	2	24	3
41.5	2	41.5	2	25	4	-	-	-	-	25	2
42	2	42	2	26	2	-	-	-	-	26	2
42.5	2	42.5	-	27	2	-	-	-	-	-	-
43	2	43	-	28	2	-	-	-	-	-	-
43.5	2	43.5	-	29	2	-	-	-	-	-	-
44	2	44	-	30	2	-	-	-	-	-	-
-	-	-	-	31	2	-	-	-	-	-	-
-	-	-	-	32	2	-	-	-	-	-	-
-	-	-	-	33	2	-	-	-	-	-	-
-	-	-	-	34	2	-	-	-	-	-	-
-	-	-	-	35	2	-	-	-	-	-	-
-	-	-	-	36	2	-	-	-	-	-	-
Total	100	Total	100	Total	100	Total	100	Total	100	Total	100

Kit / Ensemble
100/ Box - Boîte

\$ 195.00



\$ 2.25 Ea / ch.

ARCHWIRE

VELOCITY™ STAINLESS STEEL

Round	Trueform		Euroform	
	Upper 50-Pack	Lower 50-Pack	Upper 50-Pack	Lower 50-Pack
0.012	51TU-012	51TL-012	51EU-012	51EL-012
0.014	51TU-014	51TL-014	51EU-014	51EL-014
0.016	51TU-016	51TL-016	51EU-016	51EL-016
0.018	51TU-018	51TL-018	51EU-018	51EL-018
0.020	51TU-020	51TL-020	51EU-020	51EL-020

\$ 8.50 Ea / ch.

Rectangle	Upper 10-Pack	Lower 10-Pack	Upper 10-Pack	Lower 10-Pack
.016 x .016	51TU-1616	51TL-1616	51EU-1616	51EL-1616
.016 x .022	51TU-1622	51TL-1622	51EU-1622	51EL-1622
.017 x .022	51TU-1722	51TL-1722		
.017 x .025	51TU-1725	51TL-1725	51EU-1725	51EL-1725
.018 x .018	51TU-1818	51TL-1818		
.018 x .025	51TU-1825	51TL-1825	51EU-1825	51EL-1825
.019 x .025	51TU-1925	51TL-1925	51EU-1925	51EL-1925
.021 x .025	51TU-2125	51TL-2125	51EU-2125	51EL-2125

**Patient Packs
10-Pack**
Add a "P" before the dash
in any part number above.

**Patient Packs
10-Pack**
Add a "P" before the dash
in any part number above.

VELOCITY™ ARCHWIRES

THERMAL

Round	Trueform		Euroform	
	Upper 10-Pack	Lower 10-Pack	Upper 10-Pack	Lower 10-Pack
0.012	54TU-012	54TL-012	54EU-012	54EL-012
0.014	54TU-014	54TL-014	54EU-014	54EL-014
0.016	54TU-016	54TL-016	54EU-016	54EL-016
0.018	54TU-018	54TL-018	54EU-018	54EL-018
0.020	54TU-020	54TL-020	54EU-020	54EL-020

Rectangle	Upper 10-Pack	Lower 10-Pack	Upper 10-Pack	Lower 10-Pack
	.016 x .016	54TU-1616	54TL-1616	54EU-1616
.016 x .022	54TU-1622	54TL-1622	54EU-1622	54EL-1622
.017 x .025	54TU-1725	54TL-1725	54EU-1725	54EL-1725
.018 x .018	54TU-1818	54TL-1818	54EU-1818	54EL-1818
.018 x .025	54TU-1825	54TL-1825	54EU-1825	54EL-1825
.019 x .025	54TU-1925	54TL-1925	54EU-1925	54EL-1925
.020 x .020	54TU-2020	54TL-2020	54EU-2020	54EL-2020
.021 x .025	54TU-2125	54TL-2125	54EU-2125	54EL-2125

NiTi

Round	Trueform		Euroform	
	Upper 10-Pack	Lower 10-Pack	Upper 10-Pack	Lower 10-Pack
0.012	50TU-012	50TL-012	50EU-012	50EL-012
0.014	50TU-014	50TL-014	50EU-014	50EL-014
0.016	50TU-016	50TL-016	50EU-016	50EL-016
0.018	50TU-018	50TL-018	50EU-018	50EL-018
0.020	50TU-020	50TL-020	50EU-020	50EL-020

Rectangle	Upper 10-Pack	Lower 10-Pack	Upper 10-Pack	Lower 10-Pack
	.016 x .016	50TU-1616	50TL-1616	50EU-1616
.016 x .022	50TU-1622	50TL-1622	50EU-1622	50EL-1622
.017 x .025	50TU-1725	50TL-1725	50EU-1725	50EL-1725
.018 x .018	50TU-1818	50TL-1818	50EU-1818	50EL-1818
.018 x .025	50TU-1825	50TL-1825	50EU-1825	50EL-1825
.019 x .025	50TU-1925	50TL-1925	50EU-1925	50EL-1925
.020 x .020	50TU-2020	50TL-2020	50EU-2020	50EL-2020
.021 x .025	50TU-2125	50TL-2125	50EU-2125	50EL-2125

ROUND

\$ 22.00

RECTANGULAR

\$ 24.50

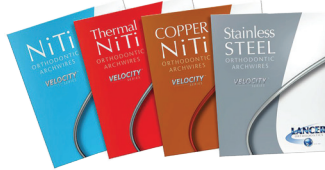

ROUND

\$ 14.95

RECTANGULAR

\$ 18.95

TITANAL™ COUNTERFORCE

Round	Original Form		Euroform	
	Upper 10-Pack	Lower 10-Pack	Upper 10-Pack	Lower 10-Pack
0.016	517-816	517-916	518-816	518-916
0.018	517-818	517-918	518-818	518-918
0.020	517-820	517-920	518-820	518-920

Rectangle	Upper 10-Pack	Lower 10-Pack	Upper 10-Pack	Lower 10-Pack
	.016 x .022	517-862	517-962	518-862
.017 x .025	517-864	517-964	518-864	518-964
.019 x .025	517-867	517-967	518-867	518-967
.021 x .025	517-868	517-968	518-868	518-968

\$ 49.50



LANCER MULTI-FORCE

Rectangle	Trueform			
	Upper 10-Pack	Lower 10-Pack	Upper 10-Pack	Lower 10-Pack
.016 x .016	538-261	538-361	538-461	538-561
.016 x .022	538-262	538-362	538-462	538-562
.017 x .025	538-264	538-364	538-464	538-564
.018 x .018	538-269	538-369	538-469	538-569
.018 x .025	538-266	538-366	538-466	538-566
.019 x .025	538-267	538-367	538-467	538-567
.020 x .020	538-265	538-365	538-465	538-565
.021 x .025	538-268	538-368	538-468	538-568

\$ 56.00



LIGATURE WIRE
SPOOLS



\$ 48.50

Round	Spool 1 Lb.
.010	575-110
.011	575-111

Ligature and
Pre-Formed



\$ 37.50

Ligature Wire Pre-Formed	Pack of 1000
.008	576-108
.009	576-109
.010	576-110
.011	576-111
.012	576-112



Ligature Wire
Shorty Pre-Formed

	Pack of 500	Pack of 1000
.010	576-311	576-310

\$ 28.00 \$ 54.00



\$ 38.00

Ligature Wire Pre-Formed Coated	Pack of 100
.012	576-512



Ligature Wire Shorty
Pre-Formed
Coated

	Pack of 100
.010	576-313

\$ 44.00



\$ 24.00

Kobayashi Auxiliary Tie Hooks	Pack of 100
.012	577-112
.014	577-114

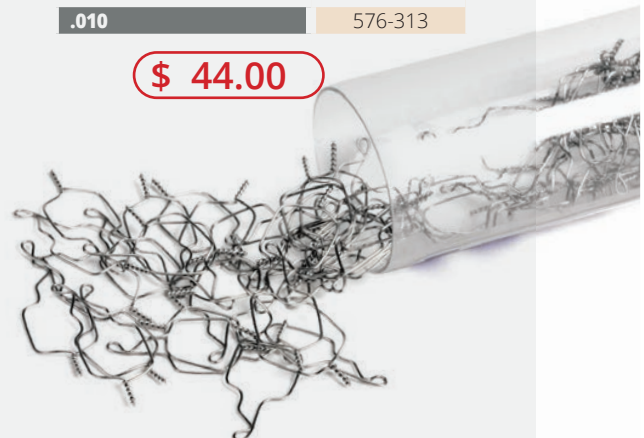

Kobayashi Shorty
Auxiliary
Tie Hooks

	Pack of 100
.012	577-115
.014	577-116

\$ 38.00

ELASTOMERIC LIGATURE TIES

Velocity™ Ties are available in two variations: Patient Sticks and Arch Sticks. They are available in 50 vibrant colors. The diameter of each ring is .120 – sized to fit any type of bracket



1,008 ties / pack

\$ 14.00

INTRA ORAL AND EXTRA ORAL ELASTICS

Latex and Non-Latex Intra Oral Elastics

Box of 3000 elastics (30 packs of 100 each)

\$ 38.00

	1/8" (3.2mm)		3/16" (4.7mm)		1/4" (6.4mm)		5/16" (7.9mm)		3/8" (9.5mm)	
Light 2oz 57g										
			Diving		Sailing		Hockey		Baseball	
	Latex	Non-Latex	Latex	Non-Latex	Latex	Non-Latex	Latex	Non-Latex	Latex	Non-Latex
	-	-	463-200	463-600	463-300	463-700	463-400	463-800	463-500	463-900
Medium 4oz 114g										
	Golf		Football		Basketball		Skating		Rodeo	
	Latex	Non-Latex	Latex	Non-Latex	Latex	Non-Latex	Latex	Non-Latex	Latex	Non-Latex
	463-101	463-550	463-201	463-601	463-301	463-701	463-401	463-801	463-501	463-901
Heavy 6oz 170g										
	Tennis		Track		Fishing		Archery		Mtn. Climbing	
	Latex	Non-Latex	Latex	Non-Latex	Latex	Non-Latex	Latex	Non-Latex	Latex	Non-Latex
	463-104	463-554	463-204	463-604	463-304	463-704	463-404	463-804	463-504	463-904
X-Heavy 8oz 227g										
			Bowling		Volleyball		Motorcycling		Water Skiing	
	Latex	Non-Latex	Latex	Non-Latex	Latex	Non-Latex	Latex	Non-Latex	Latex	Non-Latex
	-	-	463-205	-	463-305	-	463-405	-	463-505	-

Latex Extra Oral Elastics

Box of 1000 elastics (20 packs of 50 each)

\$ 38.00

	1/4" (6.4mm)	5/16" (7.9mm)	3/8" (9.5mm)	1/2" (12.7mm)
16oz 450g				
	Judo		Sumo	
	463-306		463-507	
	Karate		Boxing	
	463-406		463-506	

ELASTIC CHAIN VELOCITY™

	OOOOO Continuous	OOO Short	OO Long
Clear	ECC-01	ECS-01	ECL-01
Silver	ECC-02	ECS-02	ECL-02
White	ECC-03	ECS-03	ECL-03
Black	ECC-04	ECS-04	ECL-04
Red	ECC-05	ECS-05	ECL-05
Hot Pink	ECC-06	ECS-06	ECL-06
Light Pink	ECC-07	ECS-07	ECL-07
Green	ECC-08	ECS-08	ECL-08
Light Green	ECC-09	ECS-09	ECL-09
Dark Green	ECC-10	ECS-10	ECL-10
Blue	ECC-11	ECS-11	ECL-11
Sky Blue	ECC-12	ECS-12	ECL-12
Light Blue	ECC-13	ECS-13	ECL-13
Cobalt Blue	ECC-14	ECS-14	ECL-14
Orange	ECC-15	ECS-15	ECL-15
Yellow	ECC-16	ECS-16	ECL-16
Purple	ECC-17	ECS-17	ECL-17
Fuchsia	ECC-18	ECS-18	ECL-18
Teal	ECC-19	ECS-19	ECL-19
Aqua	ECC-20	ECS-20	ECL-20
Metallic Green	ECC-21	ECS-21	ECL-21
Bright Red	ECC-22	ECS-22	ECL-22
Fluor Green	ECC-23	ECS-23	ECL-23
Fluor Pink	ECC-24	ECS-24	ECL-24
Emerald Green	ECC-25	ECS-25	ECL-25
Tooth Color	ECC-26	ECS-26	ECL-26
Metallic Gold	ECC-27	ECS-27	ECL-27
Burgundy	ECC-28	ECS-28	ECL-28
Pearl	ECC-29	ECS-29	ECL-29
Aquamarine	ECC-30	ECS-30	ECL-30
Lime	ECC-31	ECS-31	ECL-31
Ocean Blue	ECC-32	ECS-32	ECL-32
Watermelon	ECC-33	ECS-33	ECL-33
Tangerine	ECC-34	ECS-34	ECL-34
Violet	ECC-35	ECS-35	ECL-35
Pearl Watermelon	ECC-36	ECS-36	ECL-36
Grape	ECC-37	ECS-37	ECL-37
Metallic Ocean Blue	ECC-38	ECS-38	ECL-38
Lilac	ECC-39	ECS-39	ECL-39
Navy	ECC-40	ECS-40	ECL-40
Dark Gray	ECC-41	ECS-41	ECL-41
Periwinkle	ECC-45	ECS-45	ECL-45
Lime Pearl	ECC-46	ECS-46	ECL-46
Violet Pearl	ECC-47	ECS-47	ECL-47
Bright Red Pearl	ECC-48	ECS-48	ECL-48
Blue Pearl	ECC-49	ECS-49	ECL-49

15 feet / roll
15 pieds / rouleau

\$ 14.95



All Stealth™ wire cutters include Tungsten Carbide tip inserts.



WIRE CUTTERS

Stealth™ Power Cutter
652-109
Hard/Soft Wire

\$ 98.00

Lancer Hard Wire Cutter
626-121

\$ 89.00

Lancer Hard Wire - 15 Degree
626-1000HWB

\$ 89.00

Stealth™ Hard Wire Cutter
652-006

\$ 89.00

Stealth™ Premium Hard Wire Cutter
652-006HD

\$176.00

DISTAL END SAFETY CUTTERS

Stealth™ - Distal End Flush Cut - Long
652-188

\$ 89.00

All Stealth™ distal end safety cutters include Tungsten Carbide tip inserts.

Rectangular
.022 x .027

Round
.020

Braided
.016

Stealth™ Distal End Safety Cutter Flush Cut - Long
652-188

Lancer Distal End
626-122

\$ 89.00

Lancer Distal End - Long
626-122L

\$ 89.00

Stealth™ Distal End - Flush Cut
652-102

\$ 89.00

PIN AND LIGATURE CUTTERS

Stealth™ Premium Pin & Lig Cutter
652-003HD

\$164.00

Stealth™ Premium Pin & Lig Cutter - Mini
652-004HD

\$164.00

Stealth™ - Pin & Lig Cutter 45 Degree
652-005

\$ 89.00

PIN AND LIGATURE CUTTERS



Lancer
Pin & Lig Cutter
45°
626-117

\$ 89.00



Stealth™ Premium
Pin and Ligature Cutter - Mini
652-004HD

\$164.00



Stealth™
Pin & Lig Cutter
w/ Spring
652-104

\$ 89.00



Lancer
Pin & Lig Cutter - 15°
626-118

\$ 89.00



Lancer
Pin & Lig Cutter - 7°
626-119

\$ 89.00



Lancer
Pin & Lig Cutter - Micro
626-120

\$ 89.00



Stealth™
Pin & Lig Cutter
Mini w/ Spring
652-105

\$ 89.00

GOOSE NECK PLIERS



Stealth™
Goose Neck Pliers
652-184

\$114.00

WEINGART PLIERS

Stealth™
Weingart - Regular
652-117

\$ 54.00



Lancer
Weingart - Angled
626-124

\$ 76.00



Stealth™
Weingart Pliers
652-118

\$ 76.00

HOW PLIERS



Stealth™
How Plier -
Offset Tips
652-115

\$ 54.00



Lancer
How Plier - Small Tips
626-123

\$ 54.00



Lancer
How Plier - Offset Tips
626-140

\$ 54.00



Stealth™
How Plier
Titanium Alloy
652-112

\$ 76.00



Stealth™
How Plier Regular
652-113



Stealth™
How Plier
Regular
652-113

\$ 54.00

BIRD BEAK PLIERS



Stealth™
Bird Beak
652-009

\$ 88.00



Lancer
Bird Beak
626-129

\$ 54.00



Stealth™
Bird Beak w/ Cutter
652-120

\$ 54.00



Stealth™
Bird Beak w/ TC Tips
652-121

\$118.00



Lancer
Bird Beak
w/ Square
Serrated Tips
631-023

\$285.00

FORMING PLIERS



Stealth™
Hollow Chop Plier
652-014

\$ 64.00



Lancer
Hollow Chop Plier
626-126

\$ 64.00



Stealth™ Light Wire
w/ Grooved Square Tip
652-124

\$ 98.00



Stealth™
Arch Forming Plier - Grooved
652-149

\$ 98.00



Lancer
Lingual Arch
Forming Plier
626-130

\$ 64.00



Stealth™ - Light Wire
w/ Tungsten Carbide Tips
652-126

\$ 64.00

WIRE BENDING PLIERS



**Stealth™
Nance Loop Closing Plier
652-136**

\$ 74.00



**Stealth™
Tweed Arch Bending Plier
652-012**

\$ 74.00



**Lancer
Tweed Arch Bending Plier
626-136**

\$ 74.00



**Stealth™
Adams Plier
652-141**

\$ 74.00



**Stealth™
Wire Bending Plier
652-144**

\$134.00



**Lancer
Stop Plier
626-103**

\$ 74.00



**Stealth™
Stop Plier
652-142**

\$ 74.00



**Stealth™
Heavy Three Jaw Plier
652-013**

\$ 78.00



**Stealth™
Three Jaw Plier
652-139**

\$ 78.00



**Lancer
Three Jaw Plier
626-125**

\$ 78.00

LOOP FORMING PLIERS



**Lancer
Tweed Loop
Forming
626-127**

Lancer - Tweed
3-Step Replacement Tip
(2 tips, 2 screws, hex key)
626-352T

\$ 74.00



**Lancer
Optical Plier
631-301**

\$ 74.00



**Stealth™
Tweed Loop
Forming
652-129**

\$ 86.00

LOOP FORMING PLIERS



**Stealth™
Loop Forming
652-131**

\$ 74.00



**Stealth™
Jaraback Plier
652-128**

\$ 74.00



**Stealth™
Loop Forming
w/ Replaceable Tip
652-011**

\$ 74.00

Stealth™
2-Step Replacement Tip
(2 tips, 2 screws, hex key)
652-135

LIGATING INSTRUMENTS



\$ 34.00

**Lancer
Mathieu - Ultra Fine Tip
Straight
626-138**



\$ 38.00

**Stealth™
Mathieu Hemostat
652-024**



\$ 38.00

**Stealth™
Elastic Placing Plier
Hook Tip
652-154**



**Stealth™
Ligating plier
626-155**

\$ 98.00



**Lancer
Mosquito Hemostat
626-306**

\$ 24.00



**Stealth™
Ligature Tying Plier
Coon Style
652-023**

\$ 36.00

DEBONDING INSTRUMENTS



\$ 56.00

Lancer
Bracket Removing Plier
Straight
626-346



Stealth™
Adhesive
Removing Plier
652-183

\$ 89.00



Stealth™
Bond Removing
Plier
652-021

\$ 89.00



Stealth™
Direct Bond
Removing Plier
Angled
652-019

\$ 56.00



Stealth™
Direct Bond
Removing Plier
Straight
652-020

\$ 56.00



Lancer
Bracket Removing
Plier Replacement
Blade 2/pk
626-135T

Lancer
Bracket Removing Plier
626-135

\$ 56.00

BAND TOOLS



Stealth™
Premium Posterior
Band Removing Plier
652-025HD

\$128.00



Lancer
Band Pusher
Blue 631-114
Green 631-115

\$ 28.00

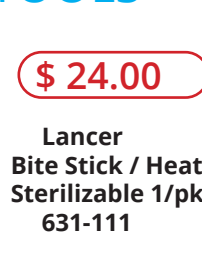

Lancer
Bite Stick / Heat
Sterilizable 1/pk
631-111

\$ 24.00



Stealth™
Posterior Band
Removing Plier
652-025

\$ 74.00



Stealth™
Posterior Band
Removing Plier - Long
652-172

\$128.00



Lancer
Band Seater
626-312

\$ 34.00



Lancer
Band Pusher
631-307

\$ 34.00

BRACKET TOOLS



Lancer - Deluxe
Bracket Holder
626-102

\$ 22.00



Lancer - Bracket
Positioning Gauge .018
631-316

\$ 48.00



Lancer - Bracket
Positioning Gauge .022
631-317

\$ 48.00



Stealth™
Boone Bracket
Positioning Gauge
652-152

\$ 26.00



Lancer
Gram Gauge
Dontrix 500gm
631-320

\$128.00

TWEEZERS
&
CRIMPING PLIERS



Stealth™
Hook Crimping
Plier
652-017

\$ 56.00



Stealth™ Bracket Placing Tweezer
652-018

\$ 28.00



Lancer Bracket Placing - Satin
626-309



Lancer - Bracket Placing - Chrome
626-100



Lancer Keat Tweezer
626-116

\$ 28.00



Lancer - Bracket Placing - Slim
631-330



Lancer
Hook Crimping
Plier
626-115

\$ 56.00

OTHER INSTRUMENTS



Lancer
1mm Step Plier
626-101

\$ 86.00



Stealth™
Separating
Plier
652-182

\$ 38.00



Stealth™
Back Plier
652-186

\$ 78.00



Lancer
Torque Plier
626-131

\$ 86.00



Lancer
Finishing Plier 3/4mm
626-150

\$ 86.00

ORTHOBOX™



OrthoBox™
Blue
626-323



OrthoBox™
Red
626-324

OrthoBox™
Green
626-325

OrthoBox™
Yellow
626-326

\$169.00



5 YEARS
WARRANTY

LANCER INSTRUMENTS

Lancer instruments are crafted from surgical stainless steel. Their screw joint design allows for easy tip alignment and adjustments. These instruments are hand-buffed to a smooth, mirror luster for corrosion resistance and are designed to repeatedly withstand all accepted methods of sterilization without losing their aesthetic qualities. Lancer instruments are available in a wide variety of the most popular designs and configurations.

STEALTH™ INSTRUMENTS

Constructed from the highest grade surgical stainless steel and the most modern, corrosion resistant materials available, Stealth instruments are designed to withstand all approved sterilization procedures. Each Stealth instrument is hand-buffed and finished by true craftsmen to ensure the finest quality and performance. Stealth's uniquely effective designs dramatically increase stability without sacrificing range of motion, enhancing control while reducing required force. Tips and cutting edges are manufactured from hardened steel or tungsten carbide for increased durability and better cutting performance over a longer period of time.



THERACAL LC



4 x 1gm. syringe - seringue

\$139.95



THERACEM

1 Dual-Syringe THERACEM - Natural (8g mixed)
15 Dual-Syringe Mixing Tips
15 Intraoral Tips
15 Root Canal Tip

\$119.95



AELITEFLO

1 x 1.5gm. syringe - seringue

\$ 27.95



ALL-BOND UNIVERSAL

1 x 6ml. bottle - bouteille

\$143.95



CHOICE 2

1 x 4.5gm. syringe - seringue

\$ 47.95



CORE-FLO DC

1 Dual-Syringe CORE-FLO DC Natural A1 (8g mixed)
15 Dual-Syringe Mixing Tips
15 Intraoral Tips
15 Root Canal Tips

\$ 71.95



DUO-LINK UNIVERSAL

1 Dual-Syringe CORE-FLO DC MILKY BRIGHT (8g mixed)
15 Dual-Syringe Mixing Tips
15 Intraoral Tips
15 Root Canal Tips

\$ 81.95



CORE-FLO DC LITE

1 Dual-Syringe CORE-FLO DC Natural A1 (8g mixed)
15 Dual-Syringe Mixing Tips
15 Intraoral Tips
15 Root Canal Tips

\$ 71.95



BISCHEM

1 Dual-Syringe CORE-FLO DC TRANSLUCENT (8g mixed)
15 Dual-Syringe Mixing Tips
15 Intraoral Tips
15 Root Canal Tips

\$ 99.95



Z-PRIME PLUS

1 x 4ml. bottle - bouteille

\$ 99.95

iDentaire

DENTAL SUPPLIES DELIVERED WITH A SMILE

www.i-dentaire.com



4D RUBBER



3 + 1



Garrison
Dental Solutions

\$ 59.00



PULPDENT®
Dental Innovation Since 1947

\$ 48.00



9791 rue Meunier,
Montréal,
QC, H3L 2Y7

Commandez par :
Order by :

TEL.: 514-669-3900
1-866-664-3320
info@i-dentaire.com